



Intelligent Health Evaluation Method of Slewing Bearing Adopting Multiple Types of Signals from Monitoring System

H. Wang^{*a,b}, R. Hong^a, J. Chen^a, M. Tang^a

^a School of Mechanical and Power Engineering, Nanjing Tech University, Nanjing, China

^b Luoyang LYC bearing Co., Ltd., Luoyang, China

PAPER INFO

Paper history:

Received 11 August 2014

Received in revised form 01 December 2014

Accepted 29 January 2015

Keywords:

Slewing Bearing

Artificial Neural Network

ELMAN

Adaptive Neuron-fuzzy Inference System

Fuzzy Clustering

Health Condition Evaluation

ABSTRACT

Slewing bearing, which is widely applied in tank, excavator and wind turbine, is a critical component of rotational machines. Standard procedure for bearing life calculation and condition assessment has been established for general rolling bearings. Nevertheless, relatively less literatures in regard to the health condition assessment of slewing bearing has been published in past. Real time health condition assessment for slewing bearing is used for avoiding catastrophic failures by detectable and preventative measurement. In this paper, a new strategy is presented for health evaluation of slewing bearing based on multiple characteristic parameters, and ANN (Artificial Neural Network) and ANFIS (Adaptive Neuro-Fuzzy Inference System) models are demonstrated to predict the health condition of slewing bearings. The prediction capabilities offered by ANN and ANFIS are shown by data obtained from full life test of slewing bearings in NJUT test System. Various statistical performance indexes have been utilized to compare the performance of two predicted models. The results suggest that ANFIS-based prediction model outperforms ANN models.

doi: 10.5829/idosi.ije2015.28.04a.12

1. INTRODUCTION

Slewing bearing is a major machine element which enables relative rotation of two structural parts, as shown in Figure 1. It is basically a large-sized bearing subjected to a compound set of loads, including axial force F_a , radial force F_r , and turnover moment M . A slewing bearing is made of inner and outer rings, rolling elements and spacers which prevent rolling elements from hitting against each other. Slewing bearing can perform both oscillating and rotating movements. The rotational speed usually ranges from 0.1 to 40 rpm. They are widely used in construction of transport devices (cranes, transporters, turning tables, etc.), wind power turbines, radars and other fields of mechanical engineering. Slewing bearing is like a joint which connects the upper part to the supporting structure. The

unexpected faults of these bearings may result in breakdown of the machine, or decrease its level of performance. Moreover, the repair is very difficult and costly, especially in some application fields like wind power turbines. Thus, a reliable real-time model is necessary to evaluate the health conditions of slewing bearings, so that timely maintenance can be performed. The traditional maintenance methods such as corrective and preventive maintenance (PM) result in overall maintenance and the waste of resource [1-3]. However, condition-based maintenance (CBM) is based on condition parameters monitoring and subsequent action [4-6].

In condition-based maintenance, machine prognosis is an important strategy to carry out the machinery maintenance depending upon its actual condition. The main function of machine prognosis is to provide knowledge of condition of rotational machine and its rate of change, so that preventive measures can be carried out at appropriate time. Knowledge about the

*Corresponding Author's Email: wanghua@njtech.edu.cn (Hua Wang)

condition of rotational machinery can be obtained by selecting some parameters that indicate machine condition deterioration such as pressure, temperature, acceleration, etc. Recently, numerous efforts have been reported in the machinery prognosis community [7-11]. Because vibration signals are directly associated with the structural dynamics as well as working condition of a machine, vibration measurement has been used for slewing bearing condition monitoring. A typical condition monitoring system is illustrated in Figure 2.

Due to slow speed and heavy load of slewing bearing representative condition, the vibrating signal is actually so weak, that results in poor signal-to-noise ratio in vibration measurement, thus making it difficult to effectively identify and diagnose the defects that are indicative of potential slewing bearing failure [12-14]. Furthermore, vibration signal is not sensitive to every potential slewing bearing failure. Hence, the accuracy of traditional evaluation result is not high. The major faults include the raceway or rolling elements spall, the rolling elements crack, and the raceway or rolling element wear. In our past experiments, it has been shown that these faults also affect rotational resistance, temperature inside the raceway, axial distance between inner and outer ring, and so on. So, it is possible to monitor the slewing bearing by other types of signals besides vibration.

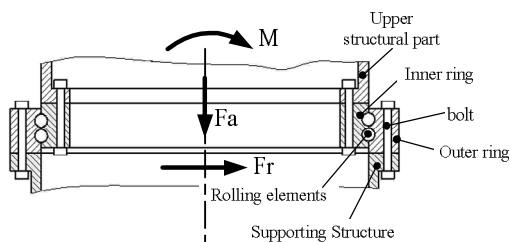

Figure 1. Typical double row slewing bearing assembly and theoretical load.

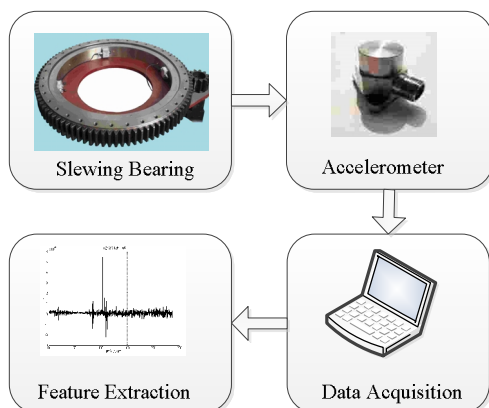

Figure 2. A typical slewing bearing condition monitoring system.

However, these types of signals vary according the types of faults. Thus, it is a nonlinear complex mapping relationship between signals and faults. Therefore, avoiding the faults information loss, this paper presents a new strategy for the health evaluation of slewing bearing adopting multiple characteristic parameters.

Then, machine health condition prognosis methods can be categorized into two major classes: physics-based and data-driven methods [15]. Physics-based methods utilize mathematical model to predict the fault growth and lifetime. For instance, Srečko Glodež [16] established a mathematical model for determination of static capacity and fatigue lifetime of large slewing bearings. However, it is difficult to develop an accurate physics-of-failure model in real-word application, especially when the low speed slewing bearing damage propagation is complex and is not fully understood.

In data-driven methods, some intelligent systems are usually used to model complex relationships between inputs and outputs, and these techniques have the excellent ability to deal with nonlinear problems. ANN and fuzzy logic have been employed successfully in the prediction of machine condition degradation [7-11, 17-19].

To make use of the fuzzy reasoning to express fuzzy language via if-then rule, fuzzy systems were incorporated in neural network. These neuro-fuzzy systems achieved better precision than ANN-based predictor. Chaochao Chen and George Vachtsevanos [20] proposed an Interval Type-2 Fuzzy Neural Network (IT2FNN) to perform multi-step-ahead condition prediction of faulty bearings. Recently, various neural network integrated with optimized method have been successfully applied to forecast the condition of bearings.

Therefore, this paper describes the use of ANN and ANFIS for estimation of health value of slewing bearings. Therefore, a fatigue life experiment system with multiple sensors were set up and the tests performed in simulated operating conditions. Then, utilizing some of the experimental data for training and verifying, ANN and ANFIS models based on BP algorithm and least square method were presented. The results show that the ANFIS model is more reliable and accurate than ANN model for slewing bearings health value.

2. METHODS

2. 1. Artificial Neural Network The Artificial Neural Network (ANN) is simulating of human brain which has the ability to derive a general solution from complicated or imprecise data [21], and have been successfully applied to automated detection and diagnosis of machine conditions [22, 23]. In brief, ANN consists of neurons as basic units. Each neuron receives

input data, and deal with them and transforms into the output unit. In this case, most widely used Back Propagation (BP) and ELMAN neuron model are proposed in Figures 3 and 4. BP is the typical feed forward ANN with three layers including one input layer, one hidden layer and one output layer, while ELMAN network, typical recurrent ANN, is established by adding one context layer based on feed forward neural network. Context layer is used to remember past activity of a hidden layer, and the local recurrent network has dynamic memory function. The same learning algorithm called variable learning rate back propagation (VLBP) was used to train the network, where the error at the output layer was moved back to the input-hidden layers for updating weights and thresholds. The main aim of ANN training is to reduce the error between real and predicted values by adjusting weights and thresholds. The output of the context nodes can be described by:

$$x_{Ol}(k) = x_l(k-1) \tag{1}$$

where $x_{Ol}(k)$ and $x_l(k)$ are, respectively, the outputs of the l th context unit and the l th hidden unit. If we assume that there are r nodes in the input layer, n nodes in the hidden and context layers, and m nodes in the output layer, then the input u is an r -dimensional vector, the output x of the hidden layer and the output x_O of the context nodes are n -dimensional vectors, the output y of the output layer is m -dimensional vector, and the weights W^1 , W^2 , and W^3 are $n \times n$, $n \times r$, and $m \times n$ dimensional matrices, respectively.

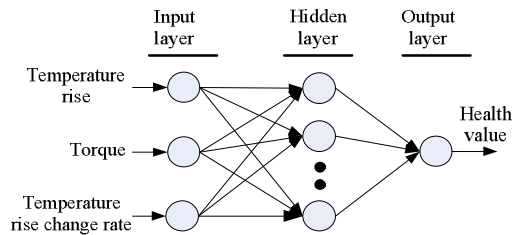

Figure 3. BP-based health evaluation model

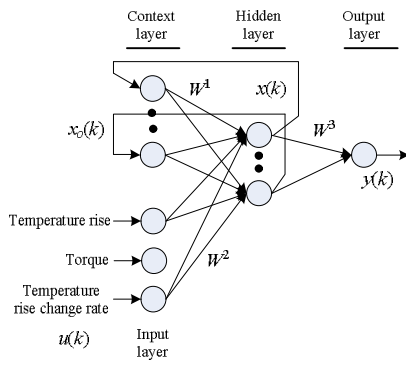

Figure 4. ELMAN-based health evaluation model

The mathematical model of the ELMAN model can be described as follows:

$$x(k) = f[W^2 u(k) + W^1 x_o(k)] \tag{2}$$

$$x_o(k) = x(k-1) \tag{3}$$

$$y(k) = g[W^3 x(k)] \tag{4}$$

where, $f(x)$ is usually taken as the tansig function

$$f(x) = \frac{1 - e^{-x}}{1 + e^{-x}} \tag{5}$$

and $g(x)$ is taken as a linear function, that is:

$$g(x) = x \tag{6}$$

The gradient descent learning algorithm is used to train the network. Let the k th desired output be $y^d(k)$, the error then can be define as:

$$E(k) = \frac{1}{2} (y^d(k) - y(k))^T (y^d(k) - y(k)) \tag{7}$$

Differentiating E with respect to W^3, W^2, W^1 , according to the gradient descent method, we obtain the following equations [24], which form the learning algorithm for the ELMAN.

$$\Delta w_{ij}^3 = \varphi_3 \delta_i^0 x_j(k) \tag{8}$$

$$\Delta w_{jq}^2 = \varphi_2 \delta_j^h u_q(k) \tag{9}$$

$$\Delta w_{jl}^1 = \varphi_1 \sum_{i=1}^m \delta_i^0 w_{ij}^3 \frac{\partial x_j(k)}{\partial w_{jl}^1} \tag{10}$$

where, $\varphi_1, \varphi_2, \varphi_3$ are the learning steps of W^3, W^2 , and W^1 , respectively, and

$$\delta_i^0 = (y_i^d(k) - y_i(k)) g'(\bullet) \tag{11}$$

$$\delta_j^h = \sum_{i=1}^m (\delta_i^0 w_{ij}^3) f'(\bullet) \tag{12}$$

$$\frac{\partial x_j(k)}{\partial w_{jl}^1} = f'_j(\bullet) x_l(k-1) \tag{13}$$

2. 2. Adaptive Neuro-fuzzy Inference System (ANFIS)

ANFIS, introduced by Roger Jang [25], is a neuro-fuzzy system which has powerful ability to learn and acquire knowledge by observing for prediction. Both artificial neural network and fuzzy logic are used in ANFIS. Neural network performs well in dealing with raw data, while fuzzy logic utilizes linguistic information to prove the reasoning ability.

ANFIS describes and analyzes the mapping relationship between input and output behavior of a nonlinear system through constructing a set of if-then

rules with appropriate membership functions (MFs). It is a combination of least squares and back propagation gradient decent methods used for training Takagi-Sugeno type fuzzy inference system. The hybrid learning algorithm makes ANFIS converge much faster and reduces the search space dimensions of the back propagation method used in neural network [26].

In this study, it is assumed that the ANFIS has three inputs and one output. The architecture of the developed ANFIS is shown in Figure 5, in which a circle indicates a fixed node, while a square indicates an adaptive node. For simplicity, it is supposed that the rule base contains three fuzzy if then rules of Takagi-Sugeno's type:

Rule 1: If (x is A_1) and (y is B_1) and (z is C_1), then ($f_1=p_1x+q_1y+r_1z+l_1$).

Rule 2: If (x is A_2) and (y is B_2) and (z is C_1), then ($f_2=p_2x+q_2y+r_2z+l_2$).

Rule 3: If (x is A_2) and (y is B_1) and (z is C_2), then ($f_3=p_3x+q_3y+r_3z+l_3$).

where A_i and B_i and C_i are the fuzzy sets, $f_i(x,y,z)$ the outputs within the fuzzy region specified by the fuzzy rule, and p_i, q_i, r_i the design parameters that are determined during the training process [27]. As described below, the ANFIS has five layers, in which the node functions of the same layer are same. The output of the i th node in layer k is defined as $O_{k,i}$. The first layer contains adaptive nodes with node functions described as:

$$\begin{aligned} O_{1,i} &= \mu_{A_i}(x) \quad \text{for } i=1,2 \text{ or} \\ O_{1,i} &= \mu_{B_{i-2}}(y) \quad \text{for } i=3,4 \text{ or} \\ O_{1,i} &= \mu_{C_{i-4}}(z) \quad \text{for } i=5,6 \end{aligned}$$

where x, y and z are the input nodes, and A, B and C the linguistic labels, and $\mu_A(x), \mu_B(y), \mu_C(z)$ the membership functions which are usually adopted the generalized Gaussian membership function

$$\mu(x) = \exp\left\{-\left(\frac{x-c_i}{a_i}\right)^2\right\} \quad (14)$$

where $\{c_i, a_i\}$ is the parameter set. Parameters are called as premise parameters. Output of the second layer is the algebraic product of all the incoming signals which is given by:

$$O_{2,i} = w_i = \mu_{A_i}(x) \times \mu_{B_{i-2}}(y) \times \mu_{C_{i-4}}(z) \quad (15)$$

The output w_i represents the firing strength of a rule. The third layer is the normalization layer, and every node in this layer is a fixed node labeled N . The i th node calculates the ratio of the i th rule's firing strength to the sum of all rules' firing strengths,

$$O_{3,i} = \bar{w}_i = \frac{w_i}{w_1 + w_2 + w_3} \quad (16)$$

In the fourth layer, the nodes are adaptive nodes. The outputs of this layer are given by:

$$O_{4,i} = \bar{w}_i f_i = \bar{w}_i (p_i x + q_i y + r_i z + l_i) \quad (17)$$

where \bar{w} is the normalized firing strength from layer 3. $\{p_i, q_i, r_i\}$ is the parameter set which are called as consequent parameters.

Finally, the fifth layer computes the overall output as the summation of all incoming signals. This layer represents the results of health value of slewing as follow:

$$O_{5,i} = f_{out} = \sum_{i=1}^3 \bar{w}_i f_i \quad (18)$$

2. 3. Clustering and Generation of ANFIS Model

In general, for a successful application of FIS to an input-output mapping problem, conformation of the number and type of membership function is essential, as well as determining a proper set of rules.

The shape of membership functions and the consequent part of an FIS is defined on the basis of specific sets of parameters. Recognition of parameters relating to the consequent part of fuzzy rules in complex systems is difficult and therefore they are usually originated from observed data using fuzzy clustering techniques [28]. The clustering is the most consequential approach in modern data mining technology, which is used to divide the set into homogenous groups based on the similarity of properties. There are two prominent fuzzy clustering, namely, subtractive and fuzzy c-mean clustering. When we have no clear idea how many clusters should be assigned for a set of data, subtractive clustering would be used. The number of clusters and the cluster centers in a dataset can be estimated. Suppose that each data point is a potential cluster center, then a measure of possibility that each data point would be defined as the cluster center is calculated based on the density of surrounding data point.

2. 4. Experiment Setup and Data Sets

A purpose-built test stand was manufactured for the fatigue life experiment of slewing bearings. As shown in Figure 6, G1, G2 and G3 are hydraulic cylinders which generate axial force F_a , radial force F_r and turnover movement T to a tested slewing bearing. And G4 is the hydraulic motor to drive the tested slewing bearing. The slewing bearing is installed between two flange shells. In order to monitor the change and growth of slewing bearing raceway damage when it is working during full life period, four temperature sensors are mounted on the outer bearing ring to ensure precise observation of operation temperature on the bearing raceway, and one torque sensor is mounted on the drive motor to measure the bearing operation torque. These analog signals or digital signals are collected by the NI data acquisition card connected to the PC through PCI bus, and the Lab VIEW software is used to do data acquisition and storage, and signal processing.

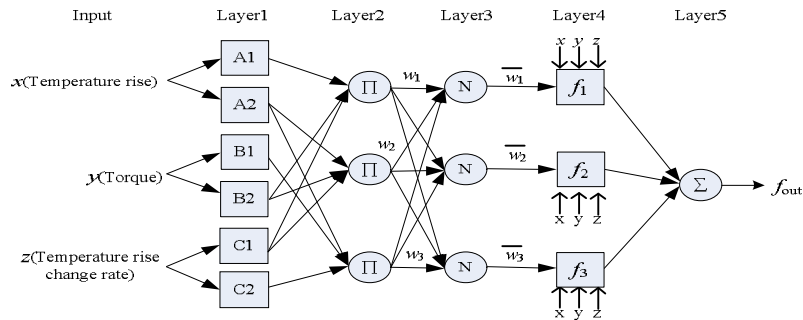

Figure 5. ANFIS architecture used in this study

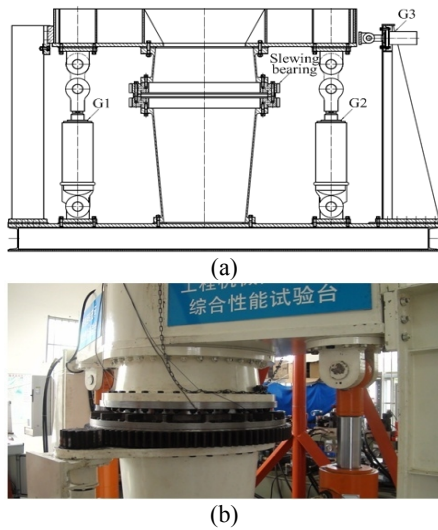

Figure 6. The experiment system, (a) Diagram of the experiment system, and (b) Test of the slewing bearing.

In this test, the type of the tested slewing bearing is QNA-730-22, of which the inner ring is the turntable ring and the outer ring is the fixed ring. The properties of the slewing bearing are shown in Table 1.

As shown in Figure 6 (b), the extreme loads are applied to the tested slewing bearing, and the rotational speed is at a 4r/min during the test. The test last seven days from new slewing bearing to disabled one.

Temperature rise, torque and temperature rise change rate were selected as the characteristic vectors of the ANN and ANFIS model in this paper. The 224 groups sample data recorded every hour were chosen to establish the evaluation models. All the data were first normalized and divided into two data sets, training (7/8 of all data) and verification (1/8 of all data). The real health value of slewing bearing is shown in Figure 7. At the beginning of test, health value is 1, and health value is 0.4 when the bearing raceway is stuck, and health value is 0 when the test is over.

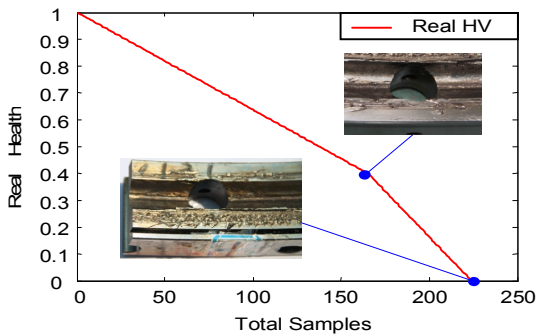

Figure 7. The real health value of the slewing bearing.

TABLE 1. Properties of the tested slewing bearing

Parameters	Value
Average Diameter	730 mm
Ball Diameter	22 mm
Extreme Axial Force	96 kN
Extreme Radial Force	35 kN
Extreme Turnover Moment	246 kN·m
Extreme Rotational Speed	10 r/min

3. RESULTS AND DISCUSSION

3.1. Model Results and Performances For the health condition evaluation of slewing bearing, the HV of slewing bearing were predicted from temperature rise, torque and temperature rise change rate by using presently developed ANN and ANFIS models. And in order to examine and compare the accuracy of two kinds of models, the variance account for VAF (Equation (19)) and the root mean square error RMSE (Equation (20)) [29] were used to compare the predicted performance of ANN and ANFIS based models.

$$VAF = \left(1 - \frac{\text{var}(y_i - \hat{y}_i)}{\text{var}(y_i)} \right) \times 100\% \tag{19}$$

$$RMSE = \sqrt{\frac{1}{N} \sum (y - \hat{y})^2} \tag{20}$$

where var symbolizes the variance, y_i is the measured value, \hat{y} the predicted value, and N the number of samples. Mean absolute percentage error (MAPE) which is an assessment of accuracy in fitted series value in statistics was also utilized for comparison of the

prediction performances of two kinds of models [30]. MAPE usually express accuracy as a percentage:

$$MAPE = \frac{1}{N} \sum_{i=1}^N \left| \frac{y_i - \hat{y}_i}{y_i} \right| \times 100\% \quad (21)$$

where y_i is the actual value and the \hat{y} the predicted value. In addition, the correlation coefficient was given by:

$$R = \frac{\sum_{i=1}^N (y_i - \bar{y})(\hat{y}_i - \bar{\hat{y}})}{\sqrt{\sum_{i=1}^N (y_i - \bar{y})^2 \sum_{i=1}^N (\hat{y}_i - \bar{\hat{y}})^2}} \quad (22)$$

3. 2. ANN Results

In ANN (BP and ELMAN network) models, the type of input variables and the number of neurons in hidden layer were determined using priori and the trial-and-error procedure. Temperature rise, torque and temperature rise change rate are included in the input vector. A neural network

with 10 neurons in its hidden layer yielded the best outputs according to the selected performance criteria. Finally, In this study, the output layer involve s one node, which represents the health value (HV). The transfer function used in the hidden layer is hyperbolic tangent sigmoid transfer function (tansig) and linear transfer function in the output layer.

As test results indicate in Table 2, BP and ELMAN ANN models with the above architecture and parameters are trained and tested 3 times, respectively. The four statistic criteria of two models are relatively similar, only the convergence epoch is largely different. By trial and error, the ELMAN3 with a convergence Epochs of 5860, a RMSE of 0.0713, a MAPE of 0.1519, a VAF of 0.9307 and a R of 0.9653, is the best model. We can conclude that the ELMAN model is better than the BP ANN model when the training mean squared errors (MSEs) of both models are 0.005.

TABLE 2. The performance comparison of BP and ELMAN models for test data by trial and error

Model	Time	MSE	Epochs	RMSE	MAPE	VAF	R
BP	1	0.005	14143	0.0781	0.2169	0.9172	0.9578
	2	0.005	9345	0.0788	0.1709	0.9163	0.9573
	3	0.005	13291	0.0812	0.2549	0.9101	0.9541
ELMAN	1	0.005	7568	0.0706	0.1738	0.9323	0.9662
	2	0.005	8645	0.0730	0.1733	0.9274	0.9638
	3	0.005	5860	0.0713	0.1519	0.9307	0.9653

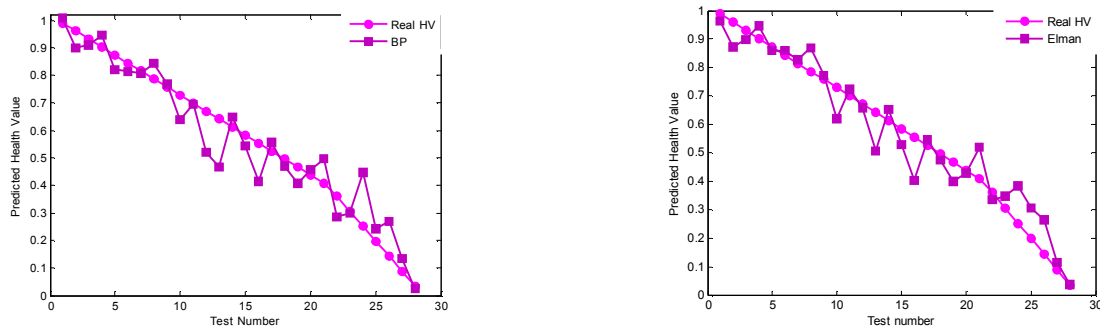

Figure 8. Comparison of predicted with actual values of HV for ELMAN and BP model.

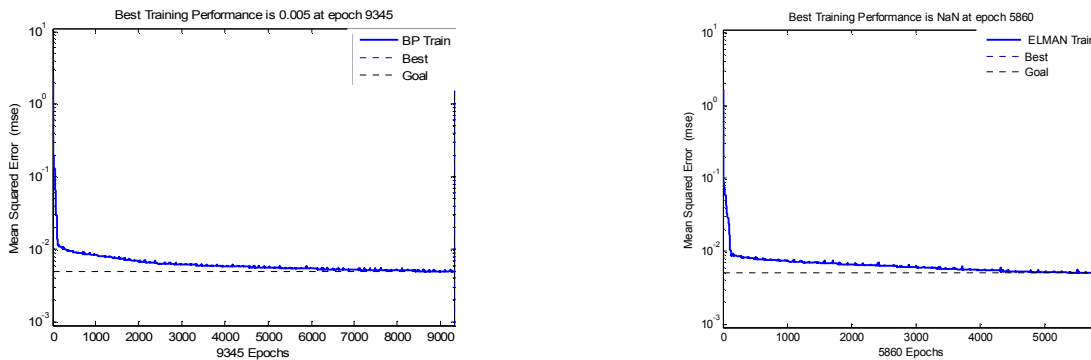

Figure 9. Training performance curve of ELMAN and BP model.

A comparison between the real and predicted health value of slewing bearing using the best trained ANN is shown in Figures 8 and 9. The convergence step of ELMAN and BP models are 9345 and 5860, respectively. That is, the convergence speed of ELMAN is faster than BP model when they have the same MSEs.

3.3. ANFIS Results In the ANFIS model, each input variable might be clustered into several class values to established fuzzy rules and each fuzzy rule would be constructed by two or more membership functions. The most traditional methods, which are utilized to classify the input data and make the rules, are grid partition, fuzzy C-means clustering and subtractive fuzzy clustering. When there are a few variable and fuzzy rules, grid partition is an appropriate method for data classification. Nevertheless, in this paper, by having 3 input variables and 6 MFs for each input variable, the rules will be 6^3 rules that obstacle the calculation of parameters. Thus, the fuzzy c-means clustering and subtractive fuzzy clustering are used in order to build up the rule relationship between the input and output variables. In this research, a Gaussian type MFs is used. Figure 10 presents a comparison between the real and forecasted HV. The results show that the developed ANFIS-based model can be effectively used for HV forecasting using the measured characteristic parameters. As the test results are shown in Table 3, there are also four criteria for making decision about the best method. The SFC-ANFIS model has the best performance (RMSE=0.0772, MAPE=0.1732, VAF=0.9510 and R=0.9753) among the ANFIS models, and the results would not be changed every training and test time. Whereas, the FCMC-ANFIS3 model with a RMES of 0.0906, a MAPE of 0.1859, a VAF of 0.0922 and a R of 0.9608 is the best test result from trial and error at the same training parameters, meaning that SFC-ANFIS model

is not stable. In addition, the SFC-ANFIS and FCMC-ANFIS3 model training and test results are shown in Figure 11. When the training epochs are 230, the performance of MSE in SFC-ANFIS model reaches 0.0028, while the MSE of 0.00309 in FCMC-ANFIS3 model. Therefore, the SFC-ANFIS is better than the FCMC-ANFIS model for HV prediction of slewing bearing.

3.4. Comparison of the Models The training and test results for comparison using the best ANN model and ANFIS model can be seen in Table 4. We can find that all of the test and training indices of SFC-ANFIS are better than those of the ELMAN except the test MAPE and RMSE. It means that the training performance of SFC-ANFIS with a training RMSE of 0.0532 and a MAPE of 0.2463 is better than that of ELMAN. Whereas just in the view of test criterion, the ELMAN with a test RMSE of 0.00713 and a test MAPE of 0.1519 can be selected as the best model, although the test RMSE and MAPE of SFC-ANFIS model is more close to that of ELMAN model. In the case of stability and robustness, the SFC-ANFIS has the absolute advantage in comparison with ELMAN, and the training epoch of SFC-ANFIS is much faster than that of ELMAN model. To visually reflect the evaluation performance of all models, the predicted results could be divided into three levels by the relative error (w), as shown in Table 5. When w is between 0 and 10%, we assume that the predicted HV is exactly conformed to the real HV, and when w is from 10 to 20%, the assessment level would be approximately matched. While w is over 20%, the assessment level would be in accuracy. w is defined as:

$$w = \left| \frac{\hat{y}_i - y_i}{y_i} \right| \quad (23)$$

where y_i is the actual value and \hat{y}_i the predicted value.

TABLE 3. The performance comparison of FCMC-NFIS and SFC-ANFIS models for test data by trial and error

Model	Test Time	MSE	Epochs	RMSE	MAPE	VAF	R
FCMC-ANFIS	1	0.00263	230	0.1096	0.2124	0.8735	0.9350
	2	0.00311	230	0.0909	0.1869	0.9202	0.9596
	3	0.00309	230	0.0906	0.1859	0.9222	0.9608
SFC-ANFIS	1	0.00283	230	0.0772	0.1732	0.9510	0.9753
	2	0.00283	230	0.0772	0.1732	0.9510	0.9753
	3	0.00283	230	0.0772	0.1732	0.9510	0.9753

TABLE 4. The performance statistics of the ANN and ANFIS models for training and test data

Model	RMSE		MAPE		VAF		R	
	Train	Test	Train	Test	Train	Test	Train	Test
BP	0.0707	0.0788	0.4227	0.1709	0.9329	0.9163	0.9659	0.9573
ELMAN	0.0707	0.0713	0.3329	0.1519	0.9329	0.9307	0.9659	0.9653
SFC-ANFIS	0.0532	0.0772	0.2277	0.1732	0.9620	0.9510	0.9808	0.9753
FCMC-ANFIS	0.0556	0.0906	0.2463	0.1859	0.9585	0.9222	0.9790	0.9608

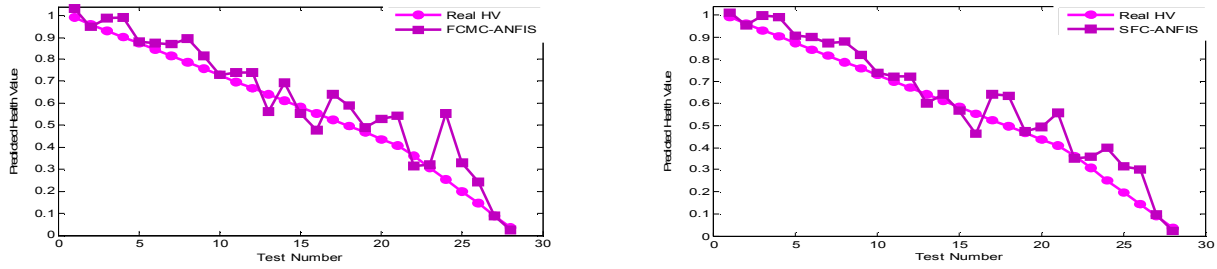

Figure 10. Comparison of predicted with actual values of HV for FCMC-ANFIS and SFC-ANFIS model.

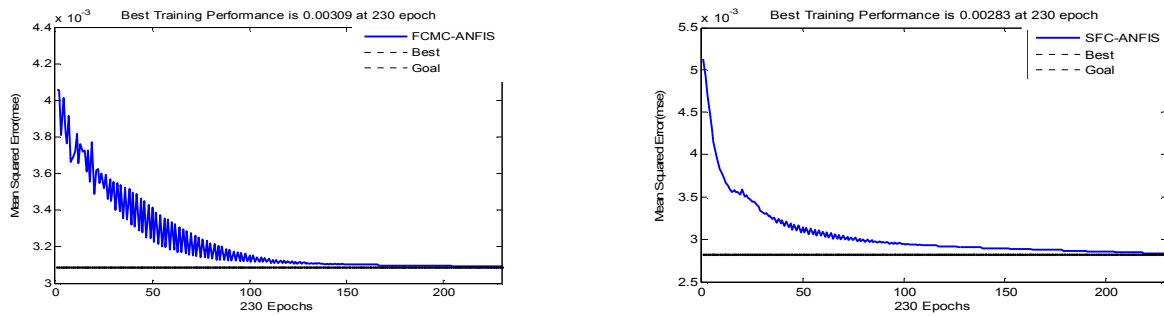

Figure 11. Training performance curve of FCMC-ANFIS and SFC-ANFIS model.

Figure 12 and Table 6 show the probability of three levels in all predicted results. By the SFC-ANFIS and ELMAN model, 17 predicted HV exactly match with the real HV of slewing bearing and 4 predicted HV approximately match. It means that the forecast accuracy of SFC-ANFIS model and ELMAN model are 60.71%, and the BP and FCMC-ANFIS model has an accuracy of 50% for HV prediction. In order to show the deviations from the real value of HV of slewing bearing, the distances of the predicted values were calculated and the graphics were also drawn in Figure 13. The graphics indicates that the deviation intervals (-0.0897 to +0.1568) of the predicted values from SFC-ANFIS are smaller than those of other models (-0.1516 to +0.1324 from ELMAN, -0.1668 to 0.1599 from BP and -0.0797 to 0.3030 from FCMC-ANFIS).

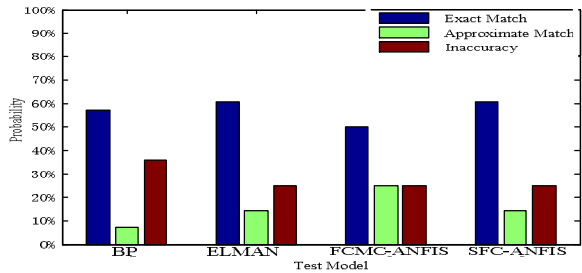

Figure 12. The percentage distribution of test results of BP, ELMAN, FCMC-ANFIS, SFC-ANFIS models.

TABLE 5. Assessment level grading of slewing bearing

Grade	Relative error of predicted HV	Assessment level
1	$0\% \leq w \leq 10\%$	Exact Match
2	$10\% < w \leq 20\%$	Approximate Match
3	$20\% < w$	Inaccuracy

TABLE 6. The numbers of three different levels of four models in test results

Model	Exact match	Approximate match	Inaccuracy
BP	14	6	8
ELMAN	17	4	7
FCMC-ANFIS	14	7	7
SFC-ANFIS	17	4	7

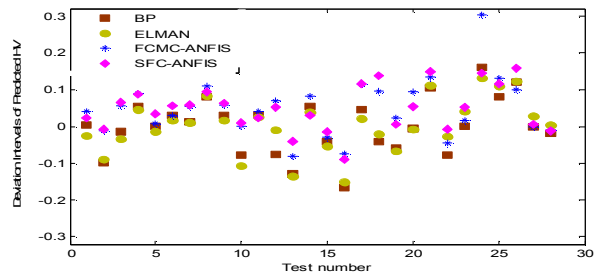

Figure 13. The deviation of the values predicted by ANN and ANFIS models from the real HVs.

4. CONCLUSIONS

Due to slow speed and heavy load of slewing bearing representative condition, the traditional vibrating signal for diagnosis is actually so weak and is not sensitive to

every potential slewing bearing failure. In this paper, a new strategy is presented for health evaluation of slewing bearing based on multiple characteristic parameters including temperature and torque.

The study has shown that the artificial neural networks and adaptive neural fuzzy inference system ANFIS models can be successfully used to predict the health value of slewing bearing. The simulation results indicated that subtractive based ANFIS model provides more reliable predictions in comparison with ANN model. In this paper, two well-known computing techniques, namely ANN and ANFIS were applied for predicted HV of slewing bearing using the full life experiment data. These simulation models were trained and tested using the characteristic variables which fully reflected the operation condition of slewing bearing. Several statistical indices were utilized for evaluating the accuracy of predictions of the simulation models. Compared in these indices between ELMAN and BP models, every index of ELMAN model is superior to BP model. It shows that the ELMAN model has a better ability to deal with nonlinear relationships. The individual comparison of ANFIS model indicates that the SFC-ANFIS model has better predictive capabilities than the FCMC-ANFIS model in all of the evaluation indices. As a view of the accuracy of predicted results, the ELMAN model with a RMSE of 0.0713 and a MAPE of 0.1519 provides the best results. However, the VAF and R is lower than SFC-ANFIS, moreover, the SFC-ANFIS convergence step is far fewer than the ELMAN model when they arrived the same MSE, namely the computation rate is fast than ELMAN. Most important of all, the SFC-ANFIS model is very stable, and the results based on the SFC-ANFIS are also very close to that of ELMAN model, while predicted results of the ELMAN and BP models are different every operation time. In conclusion, this work shows that the SFC-ANFIS model could be a powerful tool to predict HV of Slewing bearing. Finally, other types of signals or other test data will be used to continue to verify the SFC-ANFIS model.

5. ACKNOWLEDGEMENTS

The authors gratefully acknowledge the support provided by the National Natural Science Foundation of China (51105191), the Natural Science Foundation of Jiangsu province (BK2011797), and sponsored by Qing Lan Project of Jiangsu Province.

6. REFERENCES

- Tian, Z., Jin, T., Wu, B. and Ding, F., "Condition based maintenance optimization for wind power generation systems under continuous monitoring", *Renewable Energy*, Vol. 36, No. 5, (2011), 1502-1509.
- Jardine, A.K. and Tsang, A.H., "Maintenance, replacement, and reliability: Theory and applications, CRC press, (2013).
- Rawal, D., Ram, M.R. and Singh, V., "Modeling and availability analysis of internet data center with various maintenance policies", *International Journal of Transactions A: Basics*, Vol. 27, No. 4, (2014), 599-608.
- Rabbani, M., Manavizadeh, N. and Balali, S., "A stochastic model for indirect condition monitoring using proportional covariate model", *International Journal of Engineering Transactions A: Basics*, Vol. 21, No. 1, (2008), 45-56.
- Gupta, S. and Tewari, P., "Performance modeling of power generation system of a thermal plant", *International Journal of Engineering*, Vol. 24, No. 3, (2011), 239-248.
- Jin, T. and Mechehoul, M., "Minimize production loss in device testing via condition-based equipment maintenance", *Automation Science and Engineering, IEEE Transactions on*, Vol. 7, No. 4, (2010), 958-963.
- Gebraeel, N., Lawley, M., Liu, R. and Parmeshwaran, V., "Residual life predictions from vibration-based degradation signals: A neural network approach", *Industrial Electronics, IEEE Transactions on*, Vol. 51, No. 3, (2004), 694-700.
- Wang, W.Q., Golnaraghi, M.F. and Ismail, F., "Prognosis of machine health condition using neuro-fuzzy systems", *Mechanical Systems and Signal Processing*, Vol. 18, No. 4, (2004), 813-831.
- Zhao, F., Chen, J., Guo, L. and Li, X., "Neuro-fuzzy based condition prediction of bearing health", *Journal of Vibration and Control*, (2009).
- Wang, W., "An adaptive predictor for dynamic system forecasting", *Mechanical Systems and Signal Processing*, Vol. 21, No. 2, (2007), 809-823.
- Ye, Y.X. and Xiao, H.B., "Extraction of vibration signal of large-scale bearing based on wavelet analysis", *Journal of Wuhan University of Technology*, Vol. 28, (2008), 840-843.
- Yang, B.-S. and Tan, A.C.C., "Multi-step ahead direct prediction for the machine condition prognosis using regression trees and neuro-fuzzy systems", *Expert Systems with Applications*, Vol. 36, No. 5, (2009), 9378-9387.
- Jun, Q.X., Liu, Z.J., Li, H.B., "vibration and diagnosis application technology research of large rotating bearing ", *Noise and Vibration Control*, Vol. 4, (2003).
- Wang, X.D., Liu, Y.J., Yan, A.J., "predication methods of residual service lifetime for slewing bearing mounted in ladle turret", *Journal of Hubei University of Technology*, Vol. 3, (2006).
- Chen, C., Vachtsevanos, G. and Orchard, M.E., "Machine remaining useful life prediction: An integrated adaptive neuro-fuzzy and high-order particle filtering approach", *Mechanical Systems and Signal Processing*, Vol. 28, (2012), 597-607.
- Glodez, S. and Flaker, J., "Computational model for calculation of static capacity and lifetime of large slewing bearing's raceway", *Mechanism and Machine Theory*, Vol. 47, (2012), 16-30.
- Liu, J., Wang, W. and Golnaraghi, F., "A multi-step predictor with a variable input pattern for system state forecasting", *Mechanical Systems and Signal Processing*, Vol. 23, No. 5, (2009), 1586-1599.
- Samanta, B. and Nataraj, C., "Prognostics of machine condition using soft computing", *Robotics and Computer-integrated Manufacturing*, Vol. 24, No. 6, (2008), 816-823.
- Kim, Y.-H., Tan, A.C., Mathew, J. and Yang, B.-S., Condition monitoring of low speed bearings: A comparative study of the ultrasound technique versus vibration measurements, in Engineering asset management, Springer, (2006), 182-191.
- Chen, C. and Vachtsevanos, G., "Bearing condition prediction considering uncertainty: An interval type-2 fuzzy neural network approach", *Robotics and Computer-integrated Manufacturing*, Vol. 28, No. 4, (2012), 509-516.

21. Yilmaz, I. and Yuksek, G., "Prediction of the strength and elasticity modulus of gypsum using multiple regression, ann, and anfis models", *International Journal of Rock Mechanics and Mining Sciences*, Vol. 46, No. 4, (2009), 803-810.
22. Zhang, J., He, Z., Lin, S., Zhang, Y. and Qian, Q., "An anfis-based fault classification approach in power distribution system", *International Journal of Electrical Power & Energy Systems*, Vol. 49, No., (2013), 243-252.
23. Rafiee, J., Arvani, F., Harifi, A. and Sadeghi, M., "Intelligent condition monitoring of a gearbox using artificial neural network", *Mechanical Systems and Signal Processing*, Vol. 21, No. 4, (2007), 1746-1754.
24. Ge, H.-W., Qian, F., Liang, Y.-C., Du, W.-l. and Wang, L., "Identification and control of nonlinear systems by a dissimilation particle swarm optimization-based elman neural network", *Nonlinear Analysis: Real World Applications*, Vol. 9, No. 4, (2008), 1345-1360.
25. Jang, J.-S., "Anfis: Adaptive-network-based fuzzy inference system", *Systems, Man and Cybernetics, IEEE Transactions on*, Vol. 23, No. 3, (1993), 665-685.
26. Mandal, S. and Rao, S., "Damage level prediction of non-reshaped berm breakwater using ann, svm and anfis models", *International Journal of Naval Architecture and Ocean Engineering*, Vol. 4, No. 2, (2012), 112-122.
27. Esen, H. and Inalli, M., "Ann and anfis models for performance evaluation of a vertical ground source heat pump system", *Expert Systems with Applications*, Vol. 37, No. 12, (2010), 8134-8147.
28. Talebizadeh, M. and Moridnejad, A., "Uncertainty analysis for the forecast of lake level fluctuations using ensembles of ann and anfis models", *Expert Systems with Applications*, Vol. 38, No. 4, (2011), 4126-4135.
29. Iphar, M., "Ann and anfis performance prediction models for hydraulic impact hammers", *Tunnelling and Underground Space Technology*, Vol. 27, No. 1, (2012), 23-29.
30. Yilmaz, I. and Kaynar, O., "Multiple regression, ann (RBF, MLP) and anfis models for prediction of swell potential of clayey soils", *Expert Systems with Applications*, Vol. 38, No. 5, (2011), 5958-5966.

Intelligent Health Evaluation Method of Slewing Bearing Adopting Multiple Types of Signals from Monitoring System

H. Wang^{a,b}, R. Hong^a, J. Chen^a, M. Tang^a

^a School of Mechanical and Power Engineering, Nanjing Tech University, Nanjing, China

^b Luoyang LYC bearing Co., Ltd., Luoyang, China

P A P E R I N F O

چکیده

Paper history:

Received 11 August 2014

Received in revised form 01 December 2014

Accepted 29 January 2015

Keywords:

Slewing Bearing

Artificial Neural Network

ELMAN

Adaptive Neuron-fuzzy Inference System

Fuzzy Clustering

Health Condition Evaluation

بلبرینگ اسلیوینگ (slewing) که به طور گسترده در تانک، ماشین‌های خاک‌برداری و توربین بادی به کار می‌رود، یکی از اجزای مهم ماشین‌آلات چرخشی است. روش استاندارد برای محاسبه طول زندگی و شرایط ارزیابی سلامت برای یاطاقان‌های عمومی تدوین شده است. با این وجود، تحقیقات نسبتاً کمتری برای ارزیابی وضعیت سلامت از بلبرینگ اسلیوینگ شده است در گذشته منتشر شده است. ارزیابی وضعیت سلامت زمان واقعی بلبرینگ اسلیوینگ برای اجتناب از شکست فاجعه بار توسط اندازه‌گیری قابل تشخیص و پیشگیری استفاده می‌شود. در این مقاله، یک استراتژی جدید برای ارزیابی سلامت بلبرینگ اسلیوینگ بر اساس پارامترهای چندگانه مشخصه‌ها ارائه، و مدل‌های ANN (شبکه عصبی مصنوعی) و ANFIS (سیستم استنتاج تطبیقی عصبی فازی) برای پیش‌بینی وضعیت سلامت از یاطاقان اسلیوینگ نمایش داده شده است. قابلیت پیش‌بینی ارائه شده توسط ANN و ANFIS با اطلاعات به دست آمده از آزمون طول کامل عمر از یاطاقان اسلیوینگ در سیستم آزمون NJUT نشان داده شده است. شاخص عملکردهای مختلف آماری برای مقایسه عملکرد دو مدل پیش‌بینی استفاده شده است. نتایج نشان می‌دهد که مدل پیش‌بینی بر اساس ANFIS بهتر از مدل ANN است.

doi: 10.5829/idosi.ije2015.28.04a.12

