



A Genetic Algorithm Based on Optimization for Doubly Fed Induction Generator

A. Guediri*, A. Guediri, S. Touil

University of El Oued, VTRS Laboratory, Fac. Technology, El Oued, Algeria

PAPER INFO

Paper history:

Received 04 June 2021

Received in revised form 22 September 2021

Accepted 29 September 2021

Keywords:

Doubly-fed Induction Generator

Variable Speed Wind Turbine

Three-phase Acronym Pulse

Controllers Design Optimization

Genetic Algorithms

Maximum Power Point Tracking

ABSTRACT

In this paper, we will be interested in studying a system consisting of a wind turbine operating at variable wind speed, and a two-feed asynchronous machine (DFIG) connected to the grid by the stator and fed by a transducer at the side of the rotor. The conductors are separately controlled for active and reactive power flow between the stator (DFIG) and the grid. The proposed controllers generate reference voltages for the rotor to ensure that the active and reactive power reaches the required reference values, to ensure effective tracking of the optimum operating point and obtaining the maximum electrical power output. Dynamic analysis of the system is performed under the variable wind speed. This analysis is based on active and reactive energy control. The new work in this paper is to introduce theories of genetic algorithms into the control strategy used in the switching chain of wind turbines, to improve performance and efficiency. Simulation results applied to genetic algorithms give greater efficiency, impressive results, and stability to wind turbine systems compared to classic PI regulators. Then, artificial intelligent controls, such as genetic algorithms control, are applied. Results obtained, in Matlab/Simulink environment, show the efficiency of this proposed unit.

doi: 10.5829/ije.2022.35.01a.11

NOMENCLATURE

θ_{si}	Angle between the phase axis of the first stator winding and the rotor axis (rad)	$Caer_{estimated}$	Estimated aerodynamic torque (N.m)
θ_s	Angle between the axis of the first phase of the stator winding and the d axis (rad)	Qs_{ref}	The reactive power at the reference stator (VAR)
θ_r	Angle between the axis of the first phase of the rotor and the d axis (rad)	Ps_{ref}	The active power at the reference stator (W)
w_s	Electric stator pulse (rad/s)	Qs_{meas}	The reactive power at the measured stator (VAR)
$Caer$	Wind turbine aerodynamic torque (N.m)	Ps_{meas}	The active power at the measured stator (W)
Cp	Wind turbine power coefficient	Cem_{ref}	Electromagnetic torque reference (N.m)
$\Omega_{turbine_estimated}$	Estimated mechanical speed of the turbine (rad/s)	$Vestimated$	Estimated wind speed (m/s)
$B(BITA)$	Turbine blade pitch angle (rad)	λ	Relative wind speed (m/s)
g	Slip	S	Area swept by the wind turbine rotor (m ²)
Ω_{mec}	Mechanical speed (rad/s)	PL	Active line power (W)
R	Turbine radius (m)	QL	Line reactive power (VAR)
Vdc	DC bus voltage (V)	Tt	The turbine torque (N.m)
λ_{opt}	Optimal speed ratio (m/s)	fr	Rotor feed frequency (Hz)
G	Multiplier gain	Greek Symbols	
wr	Electric rotor pulsation (rad/s)	ρ	Air density at 15 ° C (kg/m ³)
Ird, Irq	Rotor current along the d axis, q (A)	Abbreviations	
Φ_s	stator flux (Wb)	MPPT	Maximum Power Point Tracking
Ps	Active stator power (W)	DFIG	Doubly-fed induction generator
Qs	Reactive stator power (VAR)	PWM	Acronym Pulse with modulation
Sr	Apparent rotor power (VA)	RSC	Rotor side converter

*Corresponding Author Email: abdelhafid-guediri@univ-eloued.dz (A. Guediri)

Please cite this article as: A. Guediri, A. Guediri, S. Touil, A Genetic Algorithm Based on Optimization for Doubly Fed Induction Generator, *International Journal of Engineering, Transactions A: Basics*, Vol. 35, No. 01, (2022), 121-129

C_{em}	Electromagnetic torque (N.m)	LSC	Line side converter
S_s	Apparent stator power (VA)	PI	Proportional Integral
w_t	Turbine speed (rad/s)	ref	Index indicating the reference (the setpoint)
Pr	Active rotor power (W)	DC/AC	Direct Current/Alternative Current
Qr	Reactive rotor power (VAR)	THD	Total Harmonic Distortion
V_s	Stator voltage vector (V)	GA	Genetic algorithm

1. INTRODUCTION

Wind energy is one of the most promising sources of renewable energies in the world, and this is mainly due to the reduction of environmental pollution resulting from classical power plants, as well as the dependence on fossil fuels with limited reserves [1]. Electric power generated from wind power plants is the fastest developing and most promising renewable energy source. The environmental degradation of air is one of the major problems that prompted authorities around the world to take a set of measures to reduce emissions of pollutants. To adapt to these new restrictions, environmentally friendly energy such as wind energy has been promoted, as many wind plants have been established in the world and are the only inexpensive and capable of mass production.

The optimization procedure is a technique of great importance for dealing with decision-making problems. It has grown significantly with the great development of computer systems technologies in terms of processing capacity and speed [2]. In fact, optimization seeks to improve performance by approaching one (or more) ideal point among many possible points or solutions based on criteria dictated by the specifications of the systems considered. It is one of the most important branches of modern applied mathematics, and a lot of practical and theoretical research has been devoted to it. Parvane et al. [3] investigated on theory includes the quantitative study of optimization methods by genetic algorithm. The solution to an optimization problem involves exploring the search space in order to maximize (or reduce) a particular function. The relative complexities (in size or structure) of the search space and functionality to be optimized lead to the use of radically different accuracy methods [4]. Optimization methods can be categorized in different ways; Deterministic and non-deterministic methods (also called stochastic or stochastic research methods), the choice of this or that method depends on the system to be studied and its complexity [5]. Deterministic methods are characterized by their simplicity and speed. They used in the case when the system to be improved has a simple structure. But the main drawback of these methods is that this simplicity decreases as the number of variables to be optimized increases and the system becomes complex.

Under these conditions, the solution can converge towards local solutions [6]. While stochastic methods are more efficient and effective methods, they use

stochastic processes based on stochastic exploration of the space of possible solutions [7]. Among the latter, we found the genetic algorithm, which represents a rather rich and interesting family of stochastic optimization algorithms. It was inspired by the concepts of evolution and natural selection. Thanks to probabilistic research based on the mechanism of natural selection and genetics, genetic algorithms are highly effective and powerful in a general set of problems. The genetic algorithm maintains a set of encoded solutions, and guides this set towards the optimal solution [8]. In fact, to find an optimal solution to a problem in a complex space, it is necessary to find a compromise between two goals: exploring better solutions and powerful exploitation of the search space. Analytical studies have shown that genetic algorithms optimally manage this trade-off [9]. This article aims to present the theoretical foundations of genetic algorithms. Next, we will discuss their request to improve the parameters of the two regulators that were previously used for DFIG speed modulation.

The main contribution of this paper has been summarized as follows:

- Study of a system consisting of a variable wind speed wind turbine and an asynchronous du-al-feed machine (DFIG) connected to the grid by a stator and fed by a transducer.
- The response of the system was verified by applying the proposed regulator in terms of its effectiveness towards the active and reactive power.
- Improvement in the results obtained through previous published works, in terms of response time, accuracy, low error, and stability.

2. MAXIMIZATION OF POWER WITHOUT SPEED CONTROL

The control model is based on the assumption that the wind speed is slightly different at a steady state. In this case, we get [10]:

$$C_{aer} = C_p \frac{1}{2} \rho S \frac{1}{\Omega_{turbine_estimated}} v_{estimated}^3 \quad (1)$$

With:

$$v_{estimated} = \frac{\Omega_{turbine_estimated} \cdot R}{\lambda} \quad (2)$$

where w_t represents the rotational speed of the wind turbine. Figure 1 Shows a typical relationship between

the power coefficient C_p and the tip-speed ratio. It should be noted that there is a value of λ to ensure a maximum of C_p . Thus, it can be stated that, for a specified wind velocity, there is a turbine rotational speed value that allows capturing the maximum mechanical power attainable from the wind, and this is, precisely, the turbine speed to be followed [11].

We set the speed ratio to the value $\lambda_{C_p \max}$ which corresponds to the maximum power factor $C_{p \max}$ and by adding the above equations, we will obtain the reference torque that is directly proportional to the square of the generator speed [12].

$$C_{em.ref} = \frac{\rho \pi R^5}{2G^3} \frac{C_p}{\lambda^3 C_{p \max}} \Omega_{mec}^2 \quad (3)$$

Figure 2 represents the diagram and the model of maximization of the power extracted without speed control.

By neglecting losses of electrical origin, the electrical power becomes equal to the electromagnetic power defined by $(\Omega_{mec} \cdot C_{em})$. This power (reference power) will be counted negatively because it is opposed to the aerodynamic power to respect the receiver convention of the assembly [13]. When these two powers are equal, the wind turbine rotates at a constant speed.

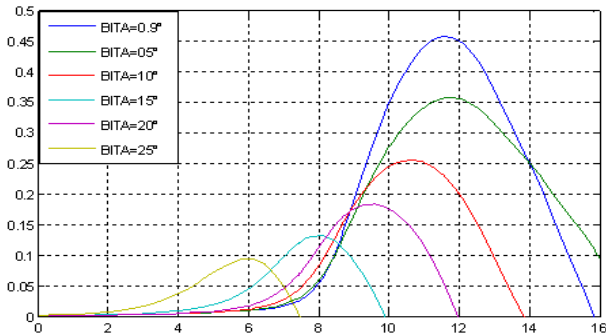

Figure 1. Typical power coefficient versus tip-speed-ratio curve

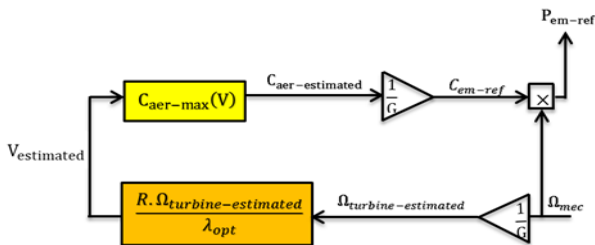

Figure 2. Power maximization block diagram extracted without speed control

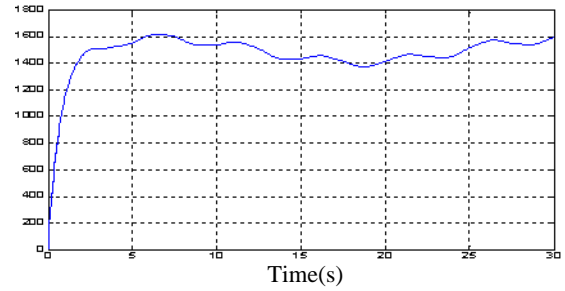

Figure 3. Mechanical speed (tr/min)

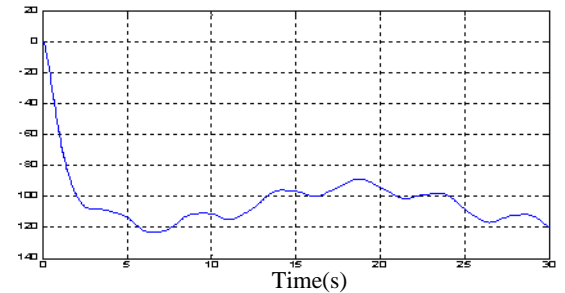

Figure 4. Electric power (N.m)

3. ACTIVE AND REACTIVE POWER CONTROL OF DFIG

The active and reactive power at grid terminals or the voltage is controlled by the reactive current flowing in the rotor converter. When the wind turbine is operated in vary regulation mode the reactive power at grid terminals is kept constant by a vary regulator. The output of the voltage regulator or varied regulator is the referenced-axis current that must be injected into the rotor by the rotor converter. The same current regulator as for the power control is used to regulate the actual direct rotor current of positive-sequence current to its reference value [14].

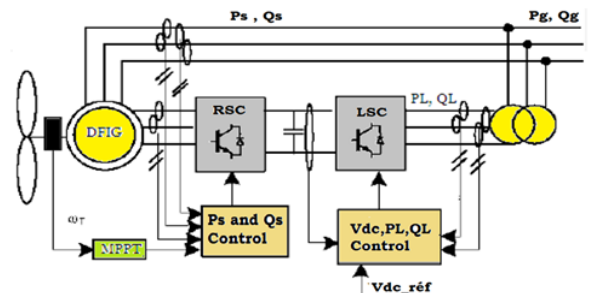

Figure 5. Powers exchange between DFIG, Converters and grid

The rotor side converter ensures a decoupled active and reactive stator power control, P_s and Q_s , according to the reference torque delivered by the Maximum Power Point Tracking control (MPPT). The grid side converter controls the power flow exchange with the grid via the rotor, by maintaining the DC bus at a constant voltage level and by imposing the reactive power [15]. The active and reactive power control equations are given below [16]:

$$\begin{aligned} S_s &= P_s + jQ_s \\ S_r &= P_r + jQ_r \end{aligned} \quad (4)$$

The active and reactive forces are shown using the following equations [17]:

$$\begin{cases} P_s = -V_s \frac{M}{L_s} \cdot I_{rq} \\ Q_s = \frac{V_s \cdot \varphi_s}{L_s} - \frac{V_s M}{L_s} I_{rd} \\ P_r = g V_s \frac{M}{L_s} \cdot I_{rq} \\ Q_r = g V_s \frac{M}{L_s} \cdot I_{rd} \end{cases} \quad (5)$$

4. ARITHMETIC CROSSING (BARYCENTRIC)

This technique was developed by "Michalewicz". For this type of crossing, we choose exchange positions randomly, then arithmetic means weighted by a coefficient a . When this operation is applied to two parents $C_1(i)$ and $C_2(i)$, two children (offspring) $E_1(i)$ and $E_2(i)$ are generated, such as [18]:

$$\begin{aligned} E_1(i) &= a C_1(i) + (1 - a)C_2(i) \\ E_2(i) &= (1 - a)C_1(i) + aC_2(i) \end{aligned} \quad (6)$$

In the case of a uniform arithmetic crossing, the value of a is a constant chosen by the user, on the other hand, if the value of a is generated randomly in the interval of [-0.5; 1.5], then we are in the case of a non-uniform arithmetic crossing. The following figure illustrates an example of the application of this type of crossing [19]: According to this figure, the two new third genes were born by:

$$\begin{cases} E_1^3(i) = a C_1^3 + (1 - a)C_2^3 \\ E_2^3(i) = (1 - a)C_1^3 + aC_2^3 \end{cases} \quad (7)$$

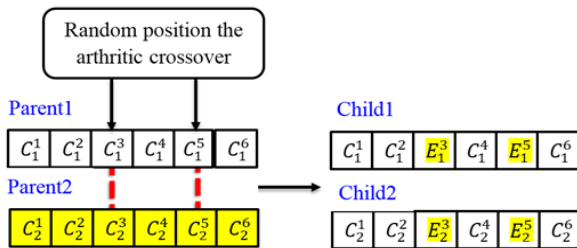

Figure 6. The arithmetic crossover

5. UNIFORM MUTATION

For each gene that mutates, we take two numbers τ and r . The first can take the values +1 for a positive change and -1 for a negative change. The second is a generated number randomly in the interval [0 1]. It determines the magnitude of the change. In these conditions, the gene C_i' which replaces the mutated gene C_i is calculated from one of the two following relationships [20]:

$$\begin{cases} C_i' = C_i + (C_{max} - C_i) \left(1 - r \left(1 - \frac{G_F}{G_T}\right)^5\right) & \text{if } \tau = +1 \\ C_i' = C_i - (C_i - C_{min}) \left(1 - r \left(1 - \frac{G_F}{G_T}\right)^5\right) & \text{if } \tau = -1 \end{cases} \quad (8)$$

here C_{max} , C_{min} denote the lower and higher limits of the price of the parameter C_i , respectively; and $G_F \leq G_T$ represents the era for which the amplitude of the mutation cancels out.

6. OPTIMIZATION PROCEDURE FOR THE TWO REGULATORS

The optimization method is a hybrid algorithm that consists of a genetic set of rules blended with a local search method (Gradient or Simplex) and which acts at the parameters of the regulator [21]. The following Figure illustrates the diagram of this method.

The procedure for optimizing regulator parameters summarized by using the following steps [22]:

- An initial offspring was born randomly.
- Evaluate this offspring.
- Apply genetic operators (selection, crossing, mutation).
- Evaluate the sort of the new offspring created through genetic operators.
- Repeat the process for a given variety of offsprings.
- Choose the best character from the new offspring.
- Use a nearby seek approach (gradient or simplex) to finalize the optimization operation achieved by using the genetic algorithm.

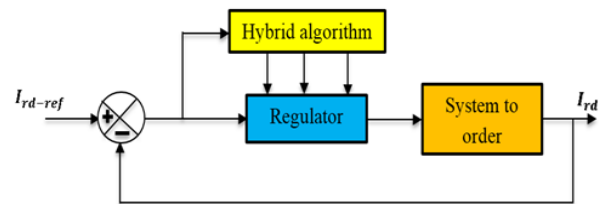

Figure 7. Principle of optimization using a genetic gradient or simplex algorithm

7. OPTIMIZATION OF THE CLASSIC PI REGULATOR

The optimization of this regulator is executed with the aid of a hybrid genetic set of the simplex rules by using the method of "Gatool" window which has been evolved by Matlab. Here are the parameters of the algorithm used [23]:

- Size of the offspring T = 20
- Selection using roulette.
- Multiple crossing with a chance $pc = 0.8$.
- Uniform mutation with opportunity $pm = 0.01$.
- Number of offspring N = 49.
- Hybridization technique: simplex.

8. SIMULATION RESULTS

To be able to show the usefulness of the optimization of classical PI gains through the genetic algorithm mixed with the simplex method, we executed out the same simulation steps supplied in this paper. From the simulation results obtained, we can observe the improvement in dynamic overall performance. The consequences of the simulation mentioned in the genetic algorithm manipulating the wind electric machine depend mainly on DFIG to supply the grid with electricity in Figure 8; where we observed a marked improvement on the dynamic level compared to the PI regulators:

Figure 9 represents the evolution of the continuous vector voltage, which shows the following:

- The DC bus voltage reaches the set point, which is 514.6 V in a shorter response time, with no overshoot.
- The shape of the DC vector voltage is smoother, which has the advantage of changing the wind speed.

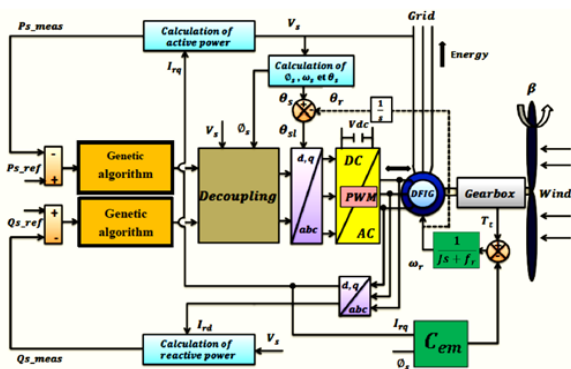

Figure 8. Global block diagram of the command of the genetic algorithm based on DFIG

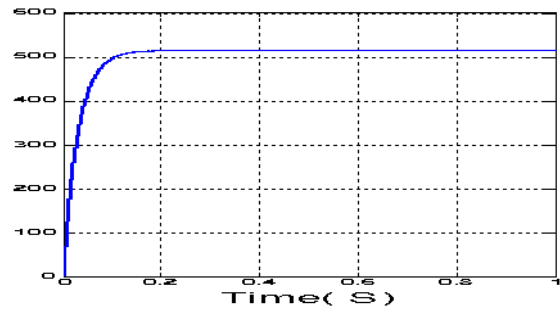

Figure 9. DC bus voltage (V)

For the robustness tests of the control by genetic algorithm regulator, we studied the influence of the variation of the rotor resistance, own inductance and mutual on the performance of the control. The simulation results of our wind power system (Turbine + DFIG) controlled by genetic algorithm regulator.

The starting is no-load then a reference active power is applied:

- Between $t = 0.2s$ and $t = 0.6 s$ negative scale ($P_{ref} = -20000W$).
 - Between $t = 0.6s$ and $t = 1s$ ($P_{ref} = - 10000W$);
- Reactive power: between $t = 0 s$ and $t = 1 s$ step ($Q_{ref} = 0 var$).

The figures below show the performance of the reactive and active stator power PI- genetic algorithm control applied to the DFIG.

Figures10 and 11 illustrate the responses of the system with the genetic algorithm controller. In general, it can be seen that the power steps are followed by the generator for both active and reactive power. However, we observe that the effect of the coupling appears on one of the two powers when changing the setpoint of the other power.

We can demonstrate the performance of these regulator in both transient and steady state using the following criteria:

- Maximum error (overshoot).
- The recovery or stabilization time (the response time).
- The residual error (the static error).

The forward and quadratic components of the rotor current are shown in Figure 12 illustrate the control error of i_{rd} and i_{rq} . From these curves, we see that: - PI regulator maintain rotor currents at their respective references imposed by stator voltage regulation; - a reduction in the load induces a reduction in the rotor current; - the error in checking i_{rd} and i_{rq} is practically zero. The result obtained are illustrated in Figure 13 shows that the electromagnetic couple perfectly followed its benchmark with good dynamic performance, less oscillation and overshoot.

Moreover, the result in Figures 14 and 15 illustrate the simulation results of the stator currents along the d and q axis and the three-phase stator currents generated by all DFIG are proportional to the active power supplied. The waveform of the current is almost sinusoidal for both stator current, which means good quality of power supplied to the grid. Figures 16 and 17 illustrate the simulation results of the stator current voltages at the terminals of the DFIG and the control voltages of the rotor, the latter were obtained by a voltage inverter controlled by the genetic algorithm and which uses MLI technique. This approach shows the waveform of the stator voltage and current. We can notice that the stator voltage is equal to that of the grid, while the waveform of the current is related to that of the active power and the reactive power.

The genetic algorithm regulator do not generate any overshoot, particularly at transient. For the other

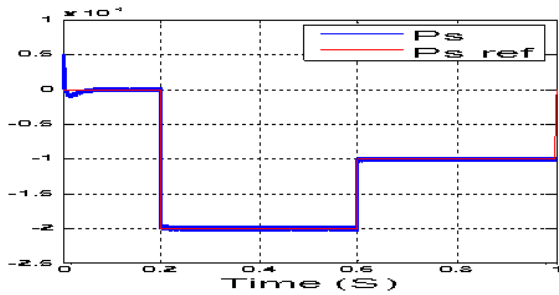

Figure 10. Active power stator (W)

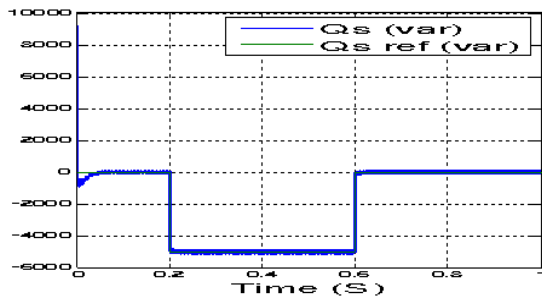

Figure 11. Reactive power stator (VAR)

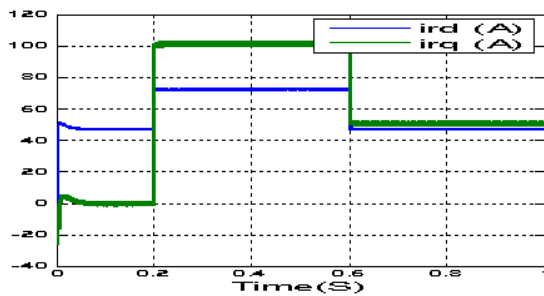

Figure 12. Direct currents and rotor quadrature(A)

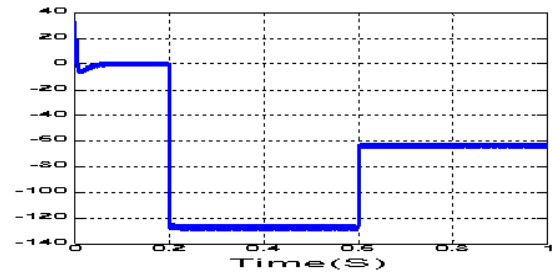

Figure 13. Electromagnetic torque (N.m)

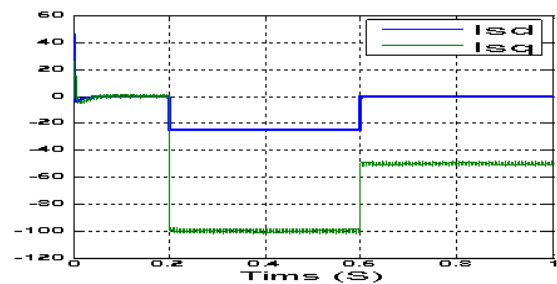

Figure 14. Direct currents and stator quadrature(A)

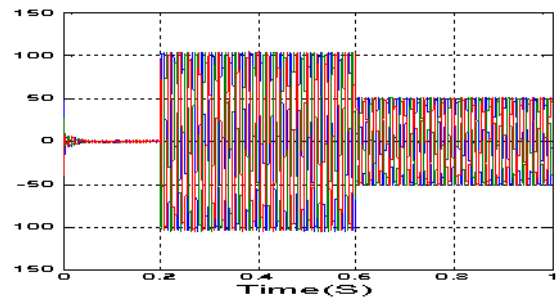

Figure 15. Rotary three-phase current (A)

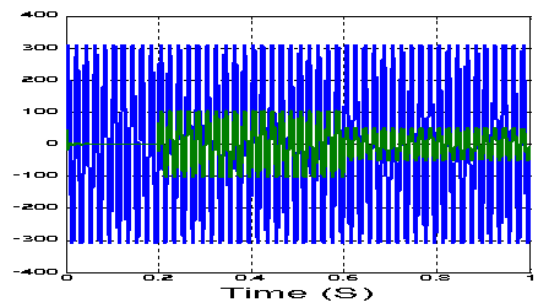

Figure 16. The stator current and voltage (V)

performances, they are almost similar to that of the PI regulator.

The regulation by genetic algorithm control shows excellence through the effective rejection of the effects of the disturbances from which the authorities trace their references completely.

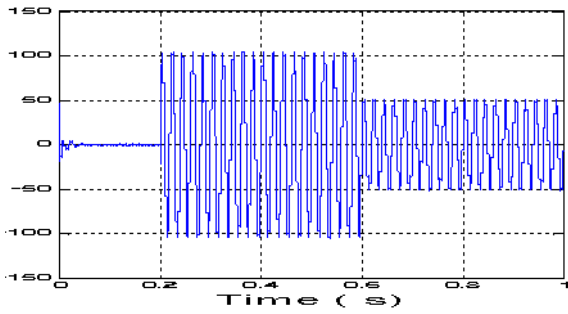

Figure 17. The stator current (A)

9. COMPARE SEARCH RESULTS WITH GRAPHICALLY RELEVANT REFERENCES

In order to measure the performance of the synthesized genetic algorithm controller and compare them with those of the conventional regulator, evaluation criteria must be defined. These criteria must take into account both the maximum amplitude of the regulator error and the time required for the system to return to the setpoint after a disturbance or to reach a new reference.

Tuning by genetic algorithm may override tuning by (PI) with respect to the quality of the dynamic response of the system. Indeed, the latter further reduces the response time by producing a limited overshoot accompanied by weak oscillations around the setpoint in steady state, the precision is not as good as that of a regulator (PI) where the integral action eliminates the static error, this then suggests the combination of the two types of regulators.

- A genetic algorithm regulator: for the transient regime.
- A regulator (PI): for the steady state.

The major drawback of genetic algorithms regulators is the matching of gains ensuring system stability. In addition, the order is calculated only from the two values: the error and the variation of the error.

The genetic algorithm applied in this article has been proven to be very effective compared to the results published in Indonesia Journal of Electrical Engineering and Computer Science under the title Optimization of PI Controller Using Genetic Algorithm for Wind Turbine Application as well as in the International Journal of System Assurance engineering and Management under the title of fuzzy modeling and control of a wind power system based on a dual-feed asynchronous machine to supply power to the electric grid. The following points are stated as:

- Response time
- Precision
- The error
- Quality
- Stability

- Exceeding
- Total Harmonic Distortion (THD)
- Sinusoidal.

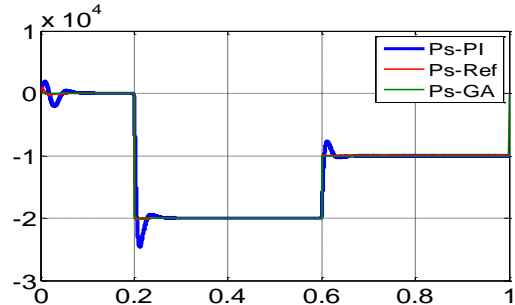

Figure 18. Active power stator (W)

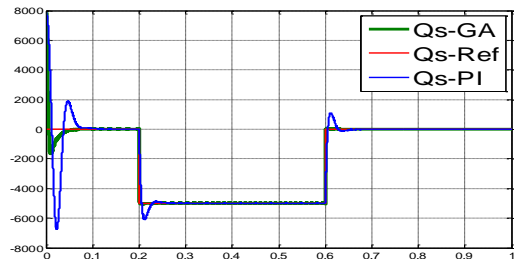

Figure 19. Reactive power stator (VAR)

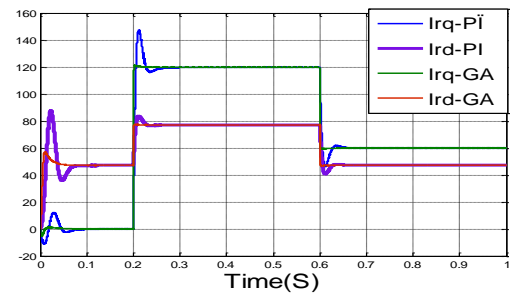

Figure 20. Direct currents and rotor quadrature(A)

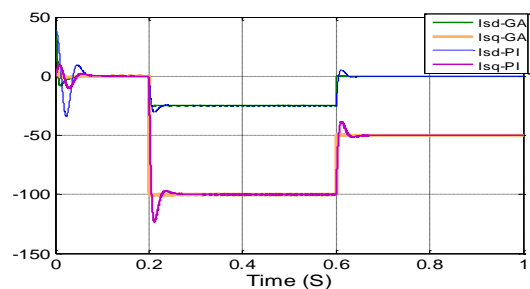

Figure 21. Direct currents and stator quadrature(A)

10. CONCLUSION

In this paper, we proposed a fuzzy logic controller and an active and reactive gene algorithm connected to a stator network (DFIG). Genetic algorithm efficacy tested under different operating conditions, demonstrating optimization and efficiency in terms of duns against changing rotor resistance, insensitivity to torque disturbance, re-reducing response time, accuracy, speed or overtaking, large overrun reduction at start-up, and avoiding peak activity power, reduced power ripples and improved THD, as well as faster dynamics with little stability error in all dynamic operating conditions. The simulation results showed good control behavior oriented towards better performance of the proposed controller.

11. APPENDIX

TABLE 1. Parameters of 1.5 MW DFIG

Symbol	Parameters	Value
R	Blade radius	35.25m
N	Number of blades	3
G	Gearbox ratio	90
J	Moment of inertia	1000 Kg.m ²
fv	Viscous friction coefficient	0.0024 N.m.s ⁻¹
V	Nominal wind speed	16 m/s
Vd	Cut-in wind speed	4 m/s
Vm	Cut-out wind speed	25 m/s

TABLE 2. Parameters of Turbine

Symbol	Parameters	Value
Pn	Rated Power	1.5 MW
Vs	Stator Voltage	300 V
Fs	Stator Frequency	50 Hz
Rs	Stator Resistance	0.012 Ω
Ls	Stator Leakage Inductance	0.0205H
Rr	Rotor Resistance	0.021Ω
Lr	Rotor Leakage Inductance	0.0204H
M	Mutual Inductance	0.0169H
P	Pairs of poles number	2
J	Rotor inertia	1000 Kg.m ²

12. REFERENCES

- Sockeel, N., Shi, J., Shahverdi, M. and Mazzola, M., "Sensitivity analysis of the battery model for model predictive control implemented into a plug-in hybrid electric vehicle", in Transportation Electrification Conference and Expo (ITEC), 2017 IEEE, (2017), 493-500, doi: 10.1109/ITEC.2017.7993320
- Suthar, B. and Patel, A., "Design optimization of axial flux surface mounted permanent magnet brushless dc motor for electrical vehicle based on genetic algorithm", *International Journal of Engineering, Transactions A Basics*, Vol. 31, No. 7, (2018), 1050-1056, doi: 10.5829/ije.2018.31.07a.07
- Parvane, M., Rahimi, E. and Jafarinejad, F., "Optimization of quantum cellular automata circuits by genetic algorithm", *International Journal of Engineering, Transactions B Applications*, Vol. 33, No. 2, (2020), 229-236, doi: 10.5829/IJE.2020.33.02B.07
- Guediri, A.K., Ben Attous, D. "Modeling and fuzzy control of a wind energy system based on double-fed asynchronous machine for supply of power to the electrical network". *International Journal of System Assurance Engineering and Management*. Vol. 8, No. 1, (2017), 353-360. doi :10.1007/s13198-015-0367-1
- Mohammed Taoussi, Mohammed Karim, Dalila Hammoumi, Chakib El Bekkali, Badre Bossoufi, Najib El Ouanjli. "Comparative study between backstepping adaptive and fieldoriented control of the DFIG applied to wind turbines", International Conference on Advanced Technologies for Signal and Image Processing (ATSIP), 2017, doi: 10.1109/ATSIP.2017.8075592
- Yamina Belgaid, M'hamed Helaimi, Rachid Taleb, Mohammed Benali Youcef " Optimal tuning of PI controller using genetic algorithm for wind turbine application ", *Indonesian Journal of Electrical Engineering and Computer Science* Vol. 18, No. 1, (2020), 167-178, doi:10.11591/ijeecs.v18.i1.
- Azari, M.N., Samami, M. and Pahnehkolaei, S.A., "Optimal design of a brushless dc motor, by cuckoo optimization algorithm (research note)", *International Journal of Engineering-Transactions B: Applications*, Vol. 30, No. 5, (2017), 668-677, doi: 10.5829/idosi.ije.2017.30.05b.06
- Patel, A. N., and B. N. Suthar. "Design optimization of axial flux surface mounted permanent magnet brushless dc motor for electrical vehicle based on genetic algorithm." *International Journal of Engineering, Transactions A Basics*, Vol. 31, No. 7 (2018), 1050-1056. doi: 10.5829/ije.2018.31.07a.07
- Hai-Hui Huang, Yong Liang. "An integrative analysis system of gene expression using self-paced learning and SCAD-Net", *Expert Systems with Applications*, Vol. 135, (2019), 102-112. doi: 10.1016/J.ESWA.2019.06.016
- Siraj K, Siraj H, and Nasir M, "Modeling and control of a doubly fed induction generator for grid integrated wind turbine," 16th International Power Electronics and Motion Control Conference and Exposition, (2014), 901-906, doi: 10.1109/EPEPEMC.2014.6980613
- Kharoubi, S. and El Menzhi, L. Wind turbine doubly-fed induction generator defects diagnosis using rotor currents lissajous curves. *International Journal of Power Electronics and Drive Systems*, Vol. 11, No. 4, (2020), 2083. doi: 10.11591/ijpeds.v11.i4.pp2083-2090
- K. S. Al-Najdi and J. Mantere, "Localized rotor overheating of large Direct on Line (DOL) motors," Petroleum and Chemical Industry Conference Europe, (2014), 1-11. doi: 10.1109/PCICEurope.2014.6900055
- S. Gao, H. Zhao, Y. Gui, D. Zhou and F. Blaabjerg, "An Improved Direct Power Control for Doubly Fed Induction Generator," in *IEEE Transactions on Power Electronics*, vol. 36, No. 4, (2021), 4672-4685, doi: 10.1109/TPEL.2020.3024620.
- Karad, Shivaji, and Ritula Thakur. "Recent trends of control strategies for doubly fed induction generator-based wind turbine systems: A comparative review." *Archives of Computational Methods in Engineering* 28.1 (2021), 15-29, doi:10.1007/s11831-019-09367-3

15. Hala Alami Aroussi, ElMostafa Ziani, Manale Bouderbala, Badre Bossoufi. "Elaborated Direct Power Control Applied to Wind Power System under Variable Speed", 7th International Renewable and Sustainable Energy Conference (IRSEC), (2019). doi: 10.1109/IRSEC48032.2019.9078307
16. Abdoune, Fateh, Djamel Aouzellag, and Kaci Ghedamsi. "Terminal voltage build-up and control of a DFIG based stand-alone wind energy conversion system." *Renewable Energy* 97 (2016), 468-480, doi: 10.1016/j.renene.2016.06.005
17. Han, Yang. "Reactive power capabilities of DFIG-based wind park for low-voltage ride through (LVRT) performance", International Conference on Quality Reliability Risk Maintenance and Safety Engineering (QR2MSE), (2013), doi: 10.1109/QR2MSE.2013.6625971
18. Huang Hai Hui, LiangYong "An integrative analysis system of gene expression using self-paced learning and SCAD-Net", *Expert Systems with Applications*, Vol. 135, (2019), 102-112, doi: 10.1016/J.ESWA.2019.06.016
19. N. Jabbour, E. Tsioumas, C. Mademlis and E. Solomin, "A Highly Effective Fault-Ride-Through Strategy for a Wind Energy Conversion System with a Doubly Fed Induction Generator," in *IEEE Transactions on Power Electronics*, Vol. 35, No. 8, (2020), 8154-8164, doi: 10.1109/TPEL.2020.2967971.
20. Delima, Allemar Jhone P., Ariel M. Sison, and Ruji P. Medina, "A Modified Genetic Algorithm with a New Crossover Mating Scheme," *Indonesian Journal of Electrical engineering and informatics*, Vol. 7, (2019), 165-181, doi: 10.11591/ijeei.v7i2.1047
21. Tan, A., Tang, Z., Sun, X. et al. Genetic Algorithm-Based Analysis of the Effects of an Additional Damping Controller for a Doubly Fed Induction Generator. *Journal of Electrical Engineering & Technology*, Vol. 15, No. 4, (2020), 1585-1593, doi :10.1007/s42835-020-00440-7
22. U. Javed, M. A. Arshad, M. Jawad, N. Shabbir, L. Kütt and A. Rassölkin, "Active and Reactive Power Control of DFIG using Optimized Fractional Order-PI Controller," 2021 IEEE International Power Electronics and Motion Control Conference (PEMC), (2021), 398-404, doi: 10.1109/PEMC48073.2021.9432608.
23. Spiegel, Jacob O., and Jacob D. Durrant. "AutoGrow4: an open-source genetic algorithm for de novo drug design and lead optimization." *Journal of Cheminformatics* 12.1 (2020), 1-16, doi: 10.1186/s13321-020-00429-4

Persian Abstract

چکیده

در این مقاله ، ما به مطالعه یک سیستم متشکل از یک توربین بادی با سرعت متغیر باد و یک ماشین ناهمزمان دو تغذیه (DFIG) علاقه مند خواهیم بود که توسط استاتور به شبکه متصل شده و توسط یک مبدل در کنار آن تغذیه می شود. روتور هادی ها به طور جداگانه برای جریان قدرت فعال و راکتیو بین استاتور (DFIG) و شبکه کنترل می شوند. کنترل کننده های پیشنهادی ولتاژهای مرجع را برای روتور ایجاد می کنند تا اطمینان حاصل شود که قدرت فعال و راکتیو به مقادیر مرجع مورد نیاز می رسد ، برای اطمینان از ردیابی موثر نقطه بهینه عملکرد و دستیابی به حداکثر توان خروجی الکتریکی. تحلیل دینامیکی سیستم تحت سرعت متغیر باد انجام می شود. این تجزیه و تحلیل بر اساس کنترل انرژی فعال و واکنش پذیر است. کار جدید در این مقاله معرفی نظریه های الگوریتم های ژنتیک در استراتژی کنترل مورد استفاده در زنجیره سوئیچ توربین های بادی ، برای بهبود عملکرد و کارایی مناسب است. نتایج شبیه سازی اعمال شده بر روی الگوریتم های ژنتیک در مقایسه با تنظیم کننده های کلاسیک PI ، کارایی ، نتایج چشمگیر و پایداری سیستم های توربین بادی را نشان می دهد. سپس ، کنترل های مصنوعی هوشمند ، مانند کنترل الگوریتم های ژنتیک ، اعمال می شوند. به نتایج به دست آمده ، در محیط Matlab/Simulink، نشان می دهد که الگوریتم ژنتیکی راندمان موثر دارد.
