



Experimental Investigation and Statistical Modeling of the Effective Parameters in Charpy Impact Test on AZ31 Magnesium Alloy with V-shape Groove Using Taguchi Method

M. R. Maraki^a, H. Tagimalek^{*b}, M. Azargoman^b, H. Khatami^c, M. Mahmoodi^b

^a Department of Materials and metallurgy, Birjand University of Technology, Birjand, Iran

^b Faculty of Mechanical Engineering, Semnan University, Semnan, Iran

^c Department of Mechanics, Urmia University, Urmia, Iran

PAPER INFO

Paper history:

Received 02 December 2019

Received in revised form 03 July 2019

Accepted 21 October 2020

Keywords:

Charpy Impact Test
AZ31 Magnesium Alloy
V-shape Groove
Taguchi
Optimization

ABSTRACT

Today, the Charpy impact test is required as a general quality control test in various industries. Several industrial standards have been formulated to perform the test accurately. It is important to determine the dynamic fracture energy in the Charpy impact test and its relation to the fracture toughness through semi-empirical equations. In the present study, the Charpy impact test on AZ31 magnesium alloy with standard ASTM E23 sample size is measured by the effect of groove depth, temperature and angle of groove on fracture energy. Taguchi and L18 arrays have been used to design the experiments and obtain the optimal state according to the number of factors studied. The effect of each input variable on the target parameter was analyzed by using ANOVA and the values of input parameters were extracted to maximize the amount of fracture energy by signal to noise method. The results showed that the groove depth has the greatest effect on the fracture energy and decreased with increasing groove depth. Also the best combination to maximize fracture energy was obtained in the non-grooved sample at -10 °C with a groove angle of 60 °.

doi: 10.5829/ije.2020.33.12c.13

1. INTRODUCTION

Today, one of the strongest alloys in the industrial is AZ31 magnesium alloy [1]. Its high strength to weight ratio, coupled with the old natural features, make it attractive for aircraft construction applications [2].

Impact testing is one of the standard methods for determining the fracture energy of materials caused by dynamic stress [3]. The basis of the impact testing is the determination of the amount of energy needed to break the component [4, 5]. The information obtained from this test is very useful in understanding how the strength of materials in real applications [6]. The purpose of the impact testing is to simulate actual conditions in an attempt to prevent failure and to predict the failure of the sample [7]. Two of the most important and common methods of impact testing are the two methods of Izod

and Charpy [8, 9]. The two methods differ only in how the samples are placed in the impact tester [10]. The behavior of the material against the instantaneous load (impact) is very different from the similar static load (tension) [11]. Impact testing is a good criterion for determining and classifying different plastics tendency for crisp behavior [12]. Given that several factors are involved in empirically determining the energy of sharp fracture (primary groove angle, groove depth, groove root radius, Exit the center of groove relative to the center of mass of the hammer, sample cross-section dimensions, radius and spacing of supports, geometry and velocity Hammer blow and primary groove making method). It is important to study the changes in these parameters and quantify the effect of these changes on the measured final energy [13, 14]. The Charpy impact test as a general quality control test in various industries is required and

*Corresponding Author Institutional Email:
h_tagimalek@semnan.ac.ir (H. Tagimalek)

several industrial standards have been accurately formulated to perform this test [15].

Druce et al. [16] investigated the effect of groove geometry and its behavior at different temperatures on the Charpy impact experiment in stainless steel. They used a cast stainless steel sample containing 25% delta ferrite for testing, which resulted in the optimal determination of the sample for fracture toughness and energy. Sidener et al. [17] investigated the numerical study of fracture energy of Charpy impacted samples for groove depth, groove angle, and groove radius on three point bending test samples in two types of U and V grooves. They used a pressure fracture tensile method to start the modeling, which stated that the results of the fitting width were 2.5 mm, which is consistent with the experimental results of other researchers. Barati et al. [18] have experimentally and numerically investigated the influence of the depth and radius of the U-shaped groove on the value of J-integrals in a three-point bending experiment. They used Elastic-Plastic to study the fracture behavior of cracked parts in specimens with high radius of plastic around the crack, which are the results of two J-integral parameters and the crack tip displacement as the fracture parameter. Salavati-Pour et al. [19] experimentally and numerically investigated the effect of groove depth and radius on the force applied in a three point bending experiment on graded steels that perform austenitic stainless steel and carbon steel. The root radius parameters of the gap are from 0.2 to 2 mm and the gap depth from 5 to 7 mm. They presented simulation results with empirical process experiments in high compatibility complex loading mode. Hossein-Zadeh et al. [20] experimentally investigated the effect of groove depth in Charpy impact testing on API X65 steel, the results of which were used in the pipeline industry and provided an equation for groove depth and fracture energy, which is linear.

The presence of geometrical discontinuities, such as grooves or holes in an object, cause an uneven distribution of stress around it or the same concentration of stress, which is the main reason for the less stress of the applied failure than the theoretical failure stress; therefore, the harmful effect of cracks, the increase in local stress, and the emergence of a three-dimensional stress state in front of the crack root, which is loaded under plane strain conditions. It is important to determine the dynamic fracture energy in the Charpy impact test and its relation to the dynamic fracture toughness through semi-empirical equation. In recent years, the U and V grooves have received much attention due to large radius of plastic zone around the groove.

Due to extensive research done on the Charpy impact test, no research was conducted on the design of experiments to investigate the failure energy. For this purpose, in the present study, at first, different variables of Charpy test including groove depth, temperature and

angle of groove were investigated. Experimental design based on Taguchi method with L18 array was designed by Minitab software and the effect of groove depth, temperature and angle on AZ31 magnesium alloy fracture energy was analyzed and the optimum case is presented.

2. MATERIALS, EQUIPMENT AND TESTS

2.1. Materials and Equipment AZ31 magnesium alloy is a thermal alloy and is commonly used in the manufacturing of components such as body panels and aircraft wings in the aerospace industry. The materials selected in this study were AZ31 magnesium alloy with dimensions of 55 mm×10 mm×10 mm. Using the quantitative test, the chemical composition and mechanical properties of the AZ31 magnesium alloy from are shown in Tables 1 and 2, respectively.

To prepare samples from the raw material, the parts are subjected to a machining process. The size, tolerance, and groove characteristics are notable features in the fabrication of the samples as shown in Figure 1, American society for testing and materials (ASTM E23) Charpy impact test. Sample machining after the final heat treatment, all machining and sealing steps are performed. Unless the impact characteristics of the samples before heat treatment and after are proved to be exactly the same. The groove should be perfectly flat, and since the change in the test results is highly influential; it is necessary to observe the transitions given in Figure 1.

TABLE 1. Chemical Composition of AZ31 Magnesium Alloy

Element	W _t (%)
Mg	Bal
Al	2.45
Zn	0.92
Mn	0.31
Cu	0.006
Ni	0.002
Si	0.07
Fe	0.023

TABLE 2. Mechanical Properties of AZ31 Magnesium Alloy

Mechanical Properties	Value
Yield Strength (Pa)	172× 10 ⁶
Ultimate Tensile Strength (Pa)	244× 10 ⁶
Elasticity Modulus (Pa)	34× 10 ⁶
Total Elongation (%)	16.7

It has been proven that high surface smoothness is not necessary, but a 2 μm surface finish is required for the grooved and opposite surface and 4 μm for the other surfaces. The groove can be struck in any way, but it must be careful not to damage the surface of the whole (the starting point of the sample failure).

Sample grooves can be pressed or machined (Chevron groove V-shape) according to API 5L3 standard, which is created by a wire cut machine and electric discharge machine. The pressing groove created in the laboratory by pressing the sample is sharp enough and there are no residual stresses in the groove tip and also the type of groove can affect the fracture start energy. In this research, the grooves were created by wire cut machine on the samples. Samples were with standard dimensions of 55 \times 10 \times 10 mm and grooves with angles of 45 to 60 degrees (18 samples with a difference of 15 degrees), groove depths of 0 to 10 mm (18 samples with 2 mm differences) and temperatures of (-10 to +10 $^{\circ}\text{C}$) using liquid nitrogen and boiling water bath (18 samples with difference of 10 $^{\circ}\text{C}$).

In order to achieve the objectives of the study, 90 Charpy samples were selected in 18 groups of 5. The impact test was performed using the Charpy Gant impact machine shown in Figure 2 with a capacity of (25 J and 40 J) with a C-shaped impactor, an 8 mm radius hammer at 23 $^{\circ}\text{C}$.

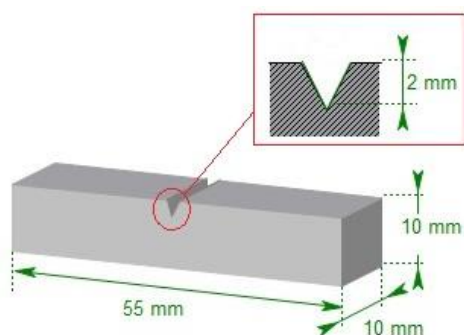

Figure 1. Standard Sample Dimensions of Charpy Impact Test



Figure 2. Charpy Gant Impact Machine

2. 2. Experimental Design Method The Taguchi method was used to design the experiments. In the present work, the factors that are important and controllable in the process of Charpy impact testing and are considered as input factors in the experiments are groove depth (mm), temperature ($^{\circ}\text{C}$) and angle respectively (degree). The range of values used in the design of the experiments is shown in Table 3.

In Table 4, considering the different levels of the three factors of groove depth, temperature and angle of the groove, the experiments were designed by Taguchi method and empirical process experiments were performed in 18 experiments. Then, a total mean failure energy response was calculated. In the following, the results of the experiments for each response are analyzed and the effect of each factor on the responses is analyzed. Table 5 illustrates the experiments designed by the Taguchi method. With respect to the L18 array used, no duplication experiments were performed in Table 5, which is one of the reasons for the reduction in the cost of experimental work in the design of the experiment.

3. RESULTS AND DISCUSSION

By designing the experiments according to the L18 array and performing the empirical experiments, the fracture energy values were extracted in Table 6 and by using ANOVA, Taguchi signal to noise and response surface diagrams, the effect of groove depth parameters, temperature and angle of groove on fracture energy, were investigated.

3. 1. Charpy Impact Test Results

After preparing the specimens for use with the Charpy impact testing machine, the samples were first used with wire cut to create groove depth and groove angle. Temperature changes were based on the parameters to reduce the temperature using liquid nitrogen and boiling water bath

TABLE 3. Range of Sharp Process Input Factor Values

Factor	Symbol	Low	High
Groove depth (mm)	H	0	10
Temperature ($^{\circ}\text{C}$)	T	-10	10
Angle of groove (degree)	A	30	60

TABLE 4. Levels for the Factors in the Experiments

Factor	level					
	1	2	3	4	5	6
Groove depth (mm)	0	2	4	6	8	10
Temperature ($^{\circ}\text{C}$)	-10	0	10	-	-	-
Angle of groove (degree)	30	45	60	-	-	-

TABLE 5. Experiments the Taguchi L18 array

Ex	Groove depth (mm)	Temperature (°C)	Angle of groove (degree)
1	0	-10	30
2	0	0	45
3	0	10	60
4	2	-10	30
5	2	0	45
6	2	10	60
7	4	-10	30
8	4	0	45
9	4	10	60
10	6	-10	30
11	6	0	45
12	6	10	60
13	8	-10	30
14	8	0	45
15	8	10	60
16	10	-10	30
17	10	0	45
18	10	10	60

was used to increase the temperature. Empirical experiments were performed at room temperature and completely identical conditions. Samples were prepared for each parameter five samples in 18 groups. The reported fracture energy is an average of five samples based on Joules. The experimental results are shown in Table 6.

According to Table 6, the Sharpe impact test was repeated 5 times for each sample and the average failure energy was obtained. It should be noted that the testing of the specimens was initially performed with a capacity of 25 Joules sharp impact machine, but the non-grooved sample exhibited a fracture energy greater than 80% capacity, so the experiment was repeated with a capacity of 40 Joules machine and the results were reported. This device has a power display system and can digitally read the sample failure energy from its monitor screen. All samples of charpy impact test have been broken, indicating the correctness of the test.

3. 2. Analysis of Variance An analysis of variance is an important method for analyzing the effect of determinants on a response [21]. Statistical analysis of variance was performed to investigate whether process parameters had a significant and statistically significant effect on fracture energy. The F-value and percentage share for each parameter indicates which input

TABLE 6. Experimental Results of the Charpy Impact Test

Ex	Sample 1	Sample 2	Sample 3	Sample 4	Sample 5	Average fracture energy (J)
1	21.85	20.68	21.54	21.37	21.90	20.90
2	21.12	20.98	21.10	21.04	21.30	20.70
3	20.78	20.95	20.90	20.8	20.57	20.80
4	11.10	10.78	10.68	10.85	10.93	10.87
5	10.42	10.12	10.35	10.45	10.65	10.74
6	9.98	10.10	9.92	9.97	9.90	9.95
7	6.03	6.10	5.89	6.03	6.17	5.98
8	5.69	5.72	5.61	5.67	5.70	5.63
9	5.51	5.49	5.38	5.43	5.41	5.36
10	3.53	3.21	3.45	3.39	3.42	3.37
11	3.12	3.07	3.21	3.13	3.10	3.18
12	3.09	2.89	2.98	3.02	3.01	3.08
13	1.69	1.63	1.78	1.69	1.71	1.66
14	1.53	1.49	1.43	1.48	1.48	1.51
15	1.32	1.25	1.29	1.27	1.21	1.30
16	0.78	0.87	0.76	0.82	0.80	0.89
17	0.64	0.63	0.59	0.62	0.61	0.64
18	0.53	0.61	0.59	0.58	0.63	0.57

parameters and how much they contribute to the response. To investigate the effect of parameters on the mean fracture energy of the mean, ANOVA using P-value was used. The P-value indicates the occurrence of the first type of error [22]. A P-value less than 0.05 indicates a significant effect of the parameter on the response [23]. For the accuracy of analysis of variance, the distribution of data must be normal. Figure 3 is a probability distribution graph for the response values where the distribution of points around the diagonal line represents the normality of the data distribution. The obtained results clearly show the effect of each factor separately and interoperable on the mean failure energy function model presented in Table 7. Among the two factors, the groove angle factor had the smallest effect on the response variations, while the groove depth factor had a significant effect on the mean failure energy response function.

The adequacy of the R² model was 99.99%, which is acceptable. The R² parameter indicates the adequacy of the model, which indicates the correct estimation of the data with the model. Equation (1) is used to calculate R²:

$$R^2 = 1 - \frac{SS_{Error}}{SS_{Total}} = \frac{SS_{Regression}}{SS_{Total}} \tag{1}$$

In this respect, SS_{Error} is the sum of squares caused by error, regression is the sum of squares caused by treatments, and SS_{Total} is the sum of squares corrected. In Equation (2) the failure energy regression model was presented:

$$E = 21.3611 + 0.0 H_1 - 10.6467 H_2 - 15.36 H_3 - 17.89 H_4 - 19.59 H_5 - 20.3967 H_6 + 0.0 T_1 - 0.2933 T_2 - 0.5133 T_3 + 0.0 A_1 + 0.0233 A_2 - 0.09 A_3 \tag{2}$$

Influence of input factors and their values are presented in Tables 7 and 8 which had the greatest effect on groove depth with 96% contribution and then temperature with

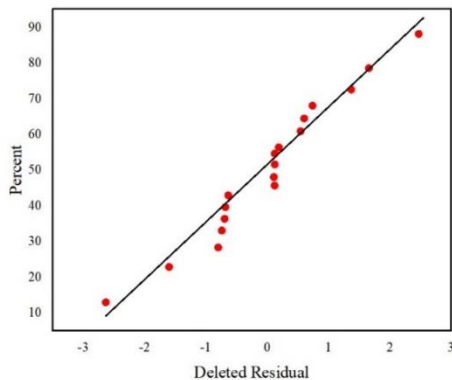

Figure 3. Normal Distribution Probability Diagram for Fracture Energy

TABLE 7. Analysis of Variance for Charpy Impact Test

Source	DF	SS	MS	F	P
Regression	9	890.008	98.890	8884.53	0.000
H	5	889.169	177.834	15977.09	0.000
T	2	0.796	0.398	35.75	0.000
A	2	0.043	0.021	1.93	0.207
Error	8	0.089	0.011		
Total	17	890.097			

R-Sq (adj)= 99.98% R-Sq= 99.99% R-Sq(pred)= 99.95%

TABLE 8. Signal to Noise Analysis Results of Charpy Impact Test

Level	H	T	A
1	26.4728	12.7248	11.6392
2	20.3549	11.8465	11.9793
3	15.1247	11.3293	12.2821
4	10.0383		
5	3.34635		
6	-3.53578		

Optimum level H₁ T₁ A₃

4% and finally groove angle had zero degree percent fracture energy on sample.

3. 3. Signal to Noise Analysis and Main Effects of Parameters For Charpy Impact Testing

Sharp impact tests were performed on laboratory samples by measuring the depth of groove failure. The average failure energy of 5 samples was then obtained from each groove depth as shown in Table 6.

By incorporating charpy impact test results into Minitab software and signal to noise analysis data into the larger is better method (since it aims to increase the failure energy of the samples). The results of the main effects of the parameters and the signal to noise are shown in Figure 4 and Table 7. Table 8 also shows the order of parameters by degree of impact.

Figure 5 illustrates the interaction effects on fracture energy. According to the values obtained from the analysis of variance and the diagrams of Figure 5, only two factors of groove depth and temperature were observed. According to the signal to noise results, the groove depth is the most effective parameter on the charpy impact test of the AZ31 samples, which decreased with increasing depth of groove energy of the samples fracture and signal to noise ratio. As the groove depth increases, the fracture energy of the sample is significantly reduced. This can be attributed to the

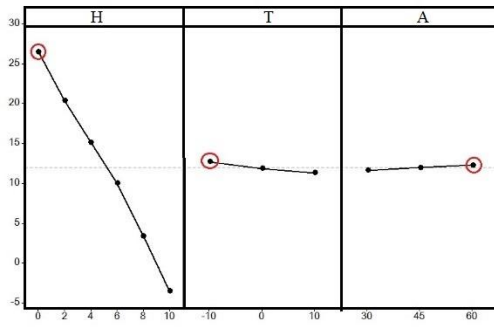

Figure 4. Main Effects Of Parameters For Fracture Energy

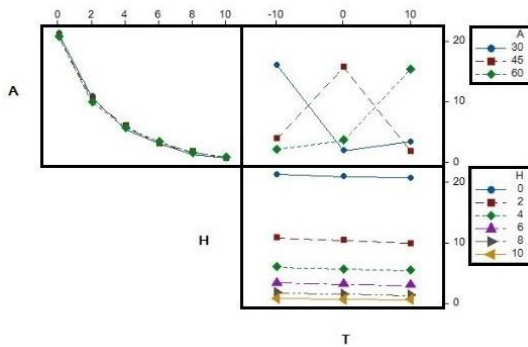

Figure 5. Diagram of Interaction of Factors on Fracture Energy

approach of the groove on the sample with neutral filament in the sample, which in experiment 1 (without groove) had the highest fracture energy, which caused the groove on the sample to weaken the sample and reduce its strength. The results of Table 7 showed that temperature is the second most effective parameter on the fracture energy of the specimens which decreases with increasing temperature, Charpy impact test and signal to noise ratio. The reason for this can be stated that with decreasing temperature, contraction is created within the material and the grains approach each other and are pressurized to each other. For this reason, the failure energy for negative temperature samples is higher than for high temperature samples. According to the results presented in Table 7, the parameter that had the least impact on the fracture energy is the groove angle. As the groove angle increases, the fracture energy and signal to noise ratio increase. In other words, the best level for the groove angle is 60 °C. The reason for this can be claimed to be the departure of the groove tip from the neutral thread.

4. RESPONSE LEVELS

Another evaluation that can be made of the influence of process parameters on output parameters is the use of

three dimensional response surface graphs. In the plots, two parameters are changed and the other parameter is kept constant. Three dimensional surfaces for groove depth, temperature, and angle are shown in Figures 6-8. Figure 5 shows that with decreasing depth of fracture energy increases and with decreasing temperature in the test specimen it is higher than the temperatures.

4. 1. Optimization With Taguchi Method

Taguchi method uses the signal to noise ratio to optimize. The term "signal" represents the desired effect for the output characteristics and the term "noise" stands for the undesirable effect for the output characteristics. Since the

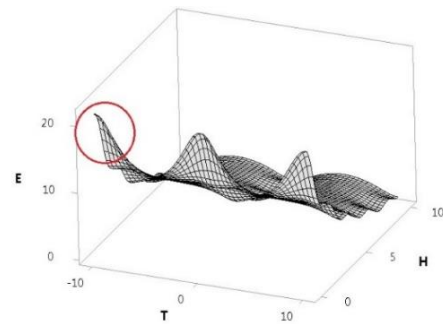

Figure 6. Three dimensional Diagram of the Effects of Groove Depth and Temperature on Fracture Energy

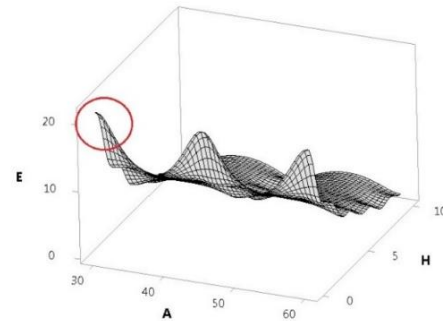

Figure 7. Three dimensional Diagram of the Effects of Groove Depth and Groove Angle on Fracture Energy

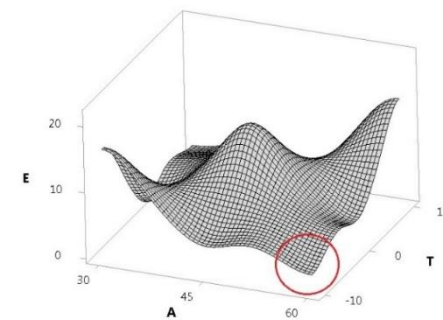

Figure 8. Three Dimensional Surface Diagram for the Effects of Groove Angle and Temperature on Fracture Energy

goal in this paper is to achieve more fracture energy, the larger is better of the signal to noise ratio was used. The larger is better equation is shown in Equation (3):

$$S/N = -10 \log_{10} \left[\frac{1}{n} (\sum_{i=1}^n y_i^2) \right] \quad (3)$$

Y_i is the response value measured in the i -th experiment and in the number of iterations per experiment. The signal to noise ratio values calculated from Equation (3) are presented using the results given in Table 7.

According to the signal to noise results in Table 9, the level of parameters having the highest signal to noise ratio is the optimal level. In the main graph, the deviation from the horizontal line indicates the greater impact of the process parameter on the response variable.

TABLE 9. Signals to Noise Results

Ex	S/N
1	26.5961
2	26.4609
3	26.3613
4	20.7086
5	20.3823
6	19.9739
7	15.6063
8	15.0717
9	14.6960
10	10.6040
11	9.9109
12	9.6001
13	4.5577
14	3.4052
15	2.0761
16	-1.7237
17	-4.1522
18	-4.7314

5. CONCLUSION

In this study, the effect of three groove depth, temperature, and groove angles on the fracture energy of the charpy impact test in AZ31 magnesium alloy was investigated. For this purpose, first, using Taguchi method, experiment design was performed. For this purpose, 90 samples were prepared in 18 groups of 5 and then the experimental results were extracted. The fracture energy of the samples was then obtained by performing a charpy impact test on the fabricated samples. The average failure energy of the five samples was then calculated for

each groove depth and the equation between the Charpy failure energy; the changes of the three factors were determined. Using the normal probability distribution graph, the normality of the data distribution was confirmed. Then, the effect of factors on each of the responses was investigated by drawing diagrams of main and interaction effects. The summary of results are:

1. According to the S/N ratio, the best combination values for maximizing fracture energy in a non-grooved sample are -10°C and a groove angle of 60° . Also the groove depth factor has the greatest impact on fracture energy.
2. ANOVA analysis showed that the greatest impact was the groove depth with 96% and then the temperature with 4% and finally the groove angle on the sample with 0° percent fracture energy.
3. Depth of groove and temperature have a significant impact on the fracture energy of the charpy impact test. By increasing the groove depth or increasing temperature, the fracture energy decreased. But regarding the effects of the groove angle due to the very small amount of fracture energy changes due to the groove angle it can be said that the effect of this factor is not significant compared to the other two factors. Concerning the interaction, it can be said that the interaction of parameters is not significant in affecting the failure energy response function.
4. Regarding the effect of parameters on the fracture energy uniformity, it can be said that the results of analysis of variance showed that the groove depth had the greatest effect on the uniformity of the transverse strain distribution after which the temperature had the greatest effect but the groove angle distance was almost ineffective. But the main effect diagrams showed that the variations of the fracture energy value were very small in the range of parameter changes and the effect of the parameters cannot be judged on the basis of the main effect diagrams. As for the interaction of parameters, the effect of groove depth, temperature, partly the interaction of groove depth and groove angle, on the transverse strain uniformity.

6. REFERENCES

1. Ghavidel, N., Allahkaram, S. R., Naderi, R., Barzegar, M., and Bakhshandeh, H., "Corrosion and wear behavior of an electroless Ni-P / nano-SiC coating on AZ31 Mg alloy obtained through environmentally-friendly conversion coating", *Surface and Coatings Technology*, Vol. 382, (2020), 125-156, <https://doi.org/10.1016/j.surfcoat.2019.125156>.
2. Fata, A., Faraji, G., Mashhadi, M. M., and Tavakkoli, V., "Hot tensile deformation and fracture behavior of ultrafine-grained AZ31 magnesium alloy processed by severe plastic deformation", *Materials Science and Engineering: A*, Vol. 674, (2016), 9-17, <https://doi.org/10.1016/j.msea.2016.07.117>.

3. Liu, F., Lin, X., Shi, J., Zhang, Y., Bian, P., Li, X., and Hu, Y., "Effect of microstructure on the Charpy impact properties of directed energy deposition 300M steel", *Additive Manufacturing*, Vol. 29, (2019), 100795, <https://doi.org/10.1016/j.addma.2019.100795>.
4. Dziubinska, A., Gontarz, A., Horzelska, K., and Piesko, P., "The microstructure and mechanical properties of AZ31 magnesium alloy aircraft brackets produced by a new forging technology", 2nd International Materials, Industrial, and Manufacturing Engineering Conference, (2015), 337-341, Doi: 10.1016/j.promfg .2015. 07.059.
5. Trojanova, Z., Gartnerova, V., Jager, A., and Namesny, A., "Mechanical and fracture properties of an AZ91 Magnesium alloy reinforced by Si and SiC particles", *Composites Science and Technology*, Vol. 69, No. 13, (2009), 2256-2264, <https://doi.org/10.1016/j.compscitech.2009.06.016>.
6. Daud, M. A. M., Nasir, N. Z., Rivai, A., and Selamat, M. Z., "Dynamic Fracture Toughness of Magnesium Alloy under Impact Loading Conditions", *Procedia Engineering*, Vol. 53, (2013), 639-644, <https://doi.org/10.1016/j.proeng.2013.02.082>.
7. Rajakumar, S., Muralidharan, C., and Balasubramanian, V., "Influence of friction stir welding process and tool parameters on strength properties of AA7075-T6 aluminium alloy joints", *Materials & Design*, Vol. 32, No. 2, (2011), 535-549. DOI:10.1016/j.matdes .2010. 08.025.
8. Hashemi, S.H., "Apportion of Charpy energy in API 5L grade X70 pipeline steel", *International Journal of Pressure Vessels and Piping*, Vol. 85, No. 12, (2008), 879-884, <https://doi.org/10.1016/j.ijpvp.2008.04.011>.
9. Hashemi, H., and Hashemi, S.H., "Investigation of Macroscopic Fracture Surface Characteristics of API X65 Steel Using Three-point Bending Test", *Modares Mechanical Engineering*, Vol. 19, No. 7, (2019), 219-228. <http://journals.modares.ac.ir/article-15-21024-fa.html>.
10. Cao, Y., Zhen, Y., Song, M., Yi, H., Li, F., and Li, X., "Determination of Johnson–Cook parameters and evaluation of Charpy impact test performance for X80 pipeline steel", *International Journal of Mechanical Sciences*, Vol. 179, (2020), 105627, <https://doi.org/10.1016/j.ijmecsci.2020.105627>
11. Tavares, S. S. M., Silva, M. B., Macedo, M. C. S. D., Strohaecker, T. R., and Costa, V. M., "Characterization of fracture behavior of a Ti alloyed supermartensitic 12%Cr stainless steel using Charpy instrumented impact tests", *Engineering Failure Analysis*, Vol. 82, (2017), 695-702, doi.org/10.1016/j.engfailanal .2017 .06.002.
12. Tanks, J., Sharp, S., and Harris, D., "Charpy impact testing to assess the quality and durability of unidirectional CFRP rods", *Polymer Testing*, Vol. 51, (2016), 63-68, doi.org/10.1016/j.polymer testing.2016. 02.009.
13. Khiratkar, V. N., Mishra, K., Srinivasulu, P., and Singh, A., "Effect of inter-lamellar spacing and test temperature on the Charpy impact energy of extremely fine pearlite", *Materials Science and Engineering: A*, Vol. 754, (2019), 622-627, <https://doi.org/10.1016/j.msea.2019. 03.121>.
14. Demirci, M. T., Tarakcioglu, N., Avci, A., and Erkendirici, O. F., "Fracture toughness of filament wound BFR and GFR arc shaped specimens with Charpy impact test method", *Composites Part B: Engineering*, Vol. 66, (2014), 7-14, doi.org/10.1016/j.compositesb .2014.04. 015.
15. Ghash, A., Sahoo, S., Ghosh, M., Ghosh, R. N., and Chakrabarti, D., "Effect of microstructural parameters, microtexture and matrix strain on the Charpy impact properties of low carbon HSLA steel containing MnS inclusions", *Materials Science and Engineering: A*, Vol. 613, (2014), 37-47, doi.org/10.1016/j.msea .2014.06.091.
16. Druce, S.G., Gage, G., and Popkiss, E., "Effects of notch geometry on the impact fracture behavior of a cast duplex stainless steel", *International Journal of Pressure Vessels and Piping*, Vol. 33, No. 1, (1988), 59-81, [doi.org/10.1016/0308-0161\(88\)90117-2](https://doi.org/10.1016/0308-0161(88)90117-2).
17. Sidener, S. E., Kumar, A. S., Oglesby, D. B., Schubert, L. E., Hamilton, M.L., and Rosinski, S. T., "Dynamic finite element modeling of the effects of size on the upper shelf energy of pressure vessel steels", *Journal of Nuclear Materials*, Vol. 239, No. 1, (1996), 210-218, [doi.org/10.1016/S0022-3115\(96\)00483-7](https://doi.org/10.1016/S0022-3115(96)00483-7).
18. Barati, E., Aghazadeh Mohandesi, J., and Alizadeh, Y., "The effect of notch depth on J-integral and critical fracture load in plates made of functionally graded aluminum–silicone carbide composite with U-notches under bending", *Materials & Design*, Vol. 31, No. 10, (2010), 4686-4692, doi.org/10.1016/j.matdes. 2010.05. 025.
19. Salavati Pour, H. S., Alizadeh, Y., and Berto, F., "Effect of notch depth and radius on the critical fracture load of bainitic functionally graded steels under mixed mode I + II loading", *Physical Mesomechanics*, Vol. 17, No. 3, (2014), 178-189, Doi: 10.1134/S1029959914030023.
20. Hosseinzadeh, A., and Hashemi, S. H., "Experimental Investigation of the effect of groove depth on sharp fracture energy in XIP X65 steel", 26th Annual Conference of the Iranian Society of Mechanical Engineers, (2018), Tehran, Iran.
21. Tewari, S. P., and Rizvi, S., "Effect of Different Welding Parameters on the Mechanical and Microstructural Properties of Stainless Steel 304H Welded Joints", *International Journal of Engineering, Transactions A: Basics*, Vol. 30, No. 10, (2017), 1592-1598, doi: 10.5829/ije.2017.30.10a.21.
22. Hoten, H., Mainil, A. K., and Mulyadi, I., "Parameters Optimization in Manufacturing Nanopowder Bioceramics of Eggshell with Pulverisette 6 Machine using Taguchi and ANOVA Method (TECHNICAL NOTE) ", *International Journal of Engineering, Transactions A: Basics*, Vol. 31, No. 1, (2018), 45-49, doi: 10.5829/ije. 2018. 31.01a. 07.
23. Afrasiabi, H. A., Khayati, G. R., and Ehteshamzadeh, M., "Studying of Heat Treatment Influence on Corrosion Behavior of AA6061-T6 by Taguchi Method", *International Journal of Engineering, Transactions C: Aspects*, Vol. 27, No. 9, (2014), 1423-1430, doi:10.5829 /idosi.ije. 2014.27. 09c .12.

Persian Abstract

چکیده

امروزه تست ضربه شاری به عنوان یک تست کنترل کیفیت عمومی در صنایع مختلف مورد نیاز است و چندین استاندارد صنعتی برای انجام دقیق این آزمون تدوین شده است. تعیین انرژی شکستگی پویا در آزمایش ضربه شاری و ارتباط آن با چقرمگی شکستگی از طریق روابط نیمه تجربی بسیار مهم است. در مطالعه حاضر، تست ضربه شاری بر روی آلیاژ منیزیم AZ31 با اندازه استاندارد ASTM E23 با استفاده از عمق شیار، دما و زاویه شیار بر انرژی شکستگی اندازه گیری شده است. از روش تاگوچی و آرایه های L18 برای طراحی آزمایش ها و بدست آوردن حالت مطلوب با توجه به تعداد فاکتورهای مورد مطالعه استفاده شده است. تأثیر هر متغیر ورودی در پارامتر هدف توسط ANOVA مورد تجزیه و تحلیل قرار گرفت و مقادیر پارامترهای ورودی برای به حداکثر رساندن مقدار انرژی شکست با استفاده از روش سیگنال به نویز استخراج شد. نتایج نشان می دهد که عمق شیار بیشترین تأثیر را در انرژی شکستگی دارد و با افزایش عمق شیار کاهش می یابد. همچنین بهترین ترکیب برای به حداکثر رساندن انرژی شکست در نمونه غیر شیار در ۱۰- درجه سانتیگراد با زاویه شیار ۶۰ درجه به دست آمد.
