



Heat Transfer Performance Analysis and Optimization of Exhaust Gas Recirculation Cooler with Different Structural Characteristics

C. H. Liu^{*a}, S. C. Li^a, C. Liu^b, J. Shi^a, D. M. Zhang^c

^a College of Automobile and Transportation Engineering, Liaoning University of Technology, Jinzhou, China

^b Jinzhou Liansheng Automobile Parts Co., Ltd., Jinzhou, China

^c BMW Brilliance Automotive Ltd., Shenyang, China

PAPER INFO

Paper history:

Received 09 June 2020

Received in revised form 03 July 2020

Accepted 03 August 2020

Keywords:

Exhaust Gas Recirculation Cooler

Heat Transfer

Fluid Simulation

Structural Optimization

ABSTRACT

In order to improve the heat transfer performance of an exhaust gas recirculation (EGR) cooler, different structural characteristics are numerically and experimentally studied. In numerical analyses, the presented pitted tube model and inner fin model, are compared under two typical working conditions, heat transfer efficiency solutions of inner fin model were 3~5% higher than that of pitted tube model. The inner fin model also gives smaller gas side pressure drop, which is only 17% of the pitted tube model. Then, the structural optimization of the inner fin model by analysing the various amplitude A was investigated. It is shown that increasing A results in increment of heat transfer efficiency and gas side pressure drop, the temperature requirement is satisfied and pressure drop is minimized when $A=0.9$ mm. The optimized numerical heat transfer efficiency solutions were 86.4% and 84%, and experimental results were 88.5% and 86.3% corresponding to working conditions, respectively. A good agreement was obtained. The optimized inner fin structure can be used efficiently to improve the heat transfer performance for an EGR cooler, the study method has been proven to be feasible by the simulations and experiments.

doi: 10.5829/ije.2020.33.10a.29

NOMENCLATURE

t_{gi}	Gas side inlet temperature (°C)	f	Darcy Friction Factor
t_{go}	Gas side outlet temperature (°C)	v_v	Volume average flow velocity (m/s)
t_{li}	Liquid side inlet temperature (°C)	v	Gas flow velocity (m/s)
t_{lo}	Liquid side outlet temperature (°C)	D	Hydraulic diameter of the pipe (m)
h	Heat transfer coefficient (W/m ² °C)	g	Gravitational constant (m/s ²)
S	Heat transfer area (m ²)	$S_{indirect}$	Indirect heat transfer area (mm ²)
S_s	Section area (m ²)	H	Distance between adjacent fins (mm)
q_m	Mass flow rate (kg/h)	L_w	Wavelength of the fins (mm)
q_{mg}	Gas mass flow rate (kg/h)	A	Amplitude of the fins (mm)
q_{ml}	Liquid mass flow rate (kg/h)	$V_{simulation}$	Value of corresponding simulation
Q	Heat exchanged between the gas and liquid (W)	$V_{experiment}$	Value of corresponding experiment
Q_g	Gas side heat loss (W)	Greek Symbols	
Q_l	Liquid side heat gain (W)	η	Heat transfer efficiency (%)
c_{pg}	Specific heat capacity of gas (J/kg°C)	ΔP	Gas side pressure drop (Pa)
c_{pl}	Specific heat capacity of liquid (J/kg°C)	ΔT_{lm}	Log-mean temperature difference (°C)
L	Length of the pipe (m)	ρ	Gas density (kg/m ³)

*Corresponding Author Institutional Email: qcxy_lch@lnut.edu.cn (C.H. Liu)

Please cite this article as: C. H. Liu, S. C. Li, C. Liu, J. Shi, D. M. Zhang, Heat Transfer Performance Analysis and Optimization of Exhaust Gas Recirculation Cooler with Different Structural Characteristics, International Journal of Engineering (IJE), IJE TRANSACTIONS A: Basics Vol. 33, No. 10, (October 2020) 2105-2112

1. INTRODUCTION

Because of the implementation of China VI emission standard, all manufacturers are developing diesel engines that satisfy the new emission regulations. EGR systems make the exhaust gas pass through a cooler and valve into the cylinder to burn again, as shown in Figure 1 [1-3], which is an important measure to reduce NOx, which is widely applied to diesel engines [4, 5].

In current products, the spiral tubes in Figure 2(a) are commonly used in an EGR cooler, the heat transfer performance of spiral structure was studied by number of researchers [2, 6-8]. The heat transfer efficiency was shown in the range of 60 to 80% [2, 6, 8, 9]. According to limited studies of pitted tubes (Figure 2b), it was found that more heat transfer area can enhance the heat transfer efficiency and increase the local turbulence of the fluid level significantly [10]. But few studies focussed on its application in an EGR cooler. Some studies considered an inner fin (Figure 2c) structure [2, 11-13] to increase heat radiating area, the efficiency was improved by about 20% compared with the spiral tubes. The fin pitch and wave pitch parameters of the inner fin was studied by number of authors [11, 13, 14] to determine their effects on transfer efficiency, but few studies focussed on the effect of the amplitude parameter in the fin structure.

Based on the above analysis, the widely used traditional spiral tube is not suitable for the strict emission standard. The application of the pitted tube in an EGR cooler has not been studied clearly yet. The inner fin structure has been proved to have good heat transfer performance due to the additional indirect heat transfer area, however the influence of the fin amplitude parameter has not been investigated yet. Hence, in this study the validation is extended and presented below.

The CFD simulation method is universally applied in numerical study [15]. An experiment is usually used to verify the simulation results [16]. Therefore, this study presents two new types of heat transfer structures, such as the pitted tube type and inner fin type, the results are investigated numerically and experimentally. Firstly, in

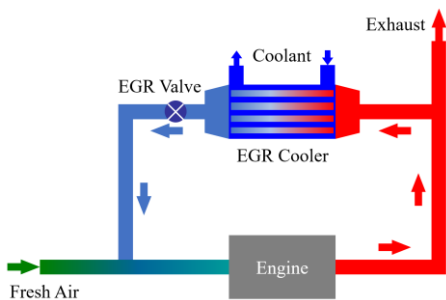

Figure 1. EGR cooler schematic diagram

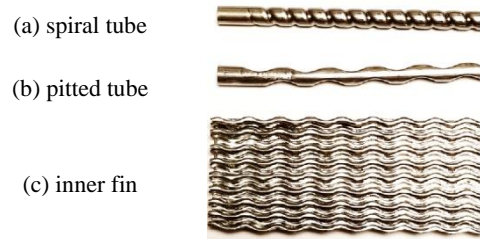

Figure 2. Heat exchange structures

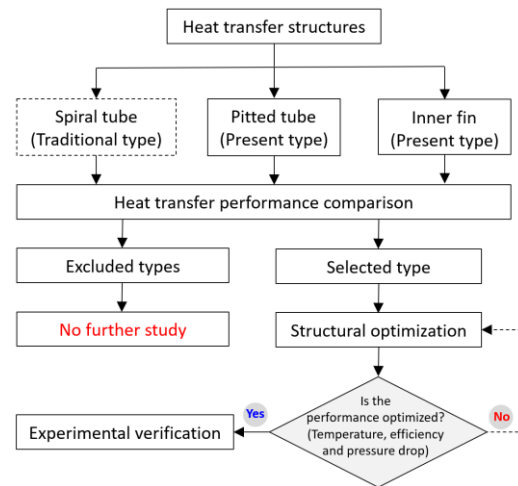

Figure 3. Flowchart of the study

section 2 two types of structures are simulated by widely used Fluent [17, 18], the heat transfer performance is analysed by comparing the gas temperature, velocity, heat transfer efficiency and pressure drop; the heat transfer efficiency of traditional spiral tube is also compared. Then, in section 3 the selected heat transfer structural parameter is optimized. Finally, in section 4 the heat transfer performance experiment is conducted to verify the numerical solutions. Figure 3 presents the flowchart of this study.

2. COMPARISON OF HEAT TRANSFER SCHEMES

2. 1. Simulation Model Three-dimensional models were established in CATIA (Figure 4). Two coolers have the same external structure size. Table 1 lists the main heat transfer schemes parameters.

The CFD models were meshed by tetrahedral elements. The material of the exhaust gas, coolant and solid were set as dry air, liquid saturated water and 316L stainless steel. A realizable k-epsilon model was selected for calculation, and upwind second-order difference equations were used for the momentum equation and energy equation.

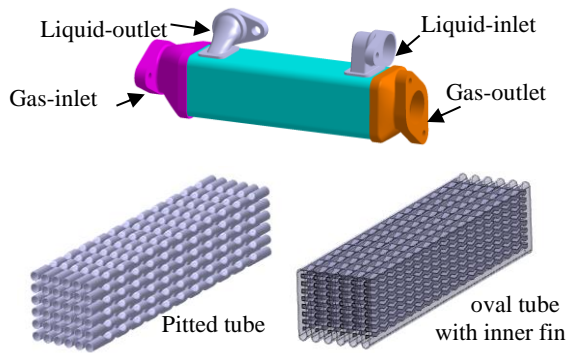

Figure 4. EGR cooler model

TABLE 1. Heat transfer schemes parameters comparison

Model	Number of tubes	Tube Length (mm)	Heat transfer area(mm ²)
Pitted tube	36	185	Direct 117534
Inner fin	6	185	Direct 103296
			Indirect 289523

2. 2. Boundary Conditions For CFD simulation, the mass flow inlet and the pressure outlet boundary conditions are adopted. According to the real engine test, two representative working conditions (as shown in Table 2) were provided by the engine works to determine the boundary conditions.

2. 3. Simulation Results and Discussion One longitudinal and nine transverse (including inlet and outlet) sections were selected to show the results as defined in Figure 5. Figures 6 and 7 show the gas side temperature distribution and area average velocity under each working condition, respectively. For convenience of comparison, figures chose the same contour range. The area average temperature and velocity data of transverse sections are plotted in Figures 8 and 9. Tables 3 and 4 compare the simulation results of the two kinds of different heat transfer structures under two working conditions. Equation (1) calculates the heat transfer efficiency η [19]. Figure 10 compares heat transfer efficiency values of three types of EGR coolers.

$$\eta = (t_{gi} - t_{go}) / (t_{gi} - t_{li}) \quad (1)$$

TABLE 2. Boundary conditions

Working condition	Inlet flow (kg/h)		Inlet temperature(°C)		Target gas outlet(°C)
	Liquid	Gas	Liquid	Gas	
1	1500	78	84.5	495	140
2	1500	86.5	84.0	420	140

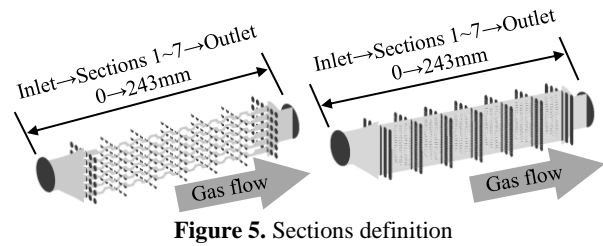

Figure 5. Sections definition

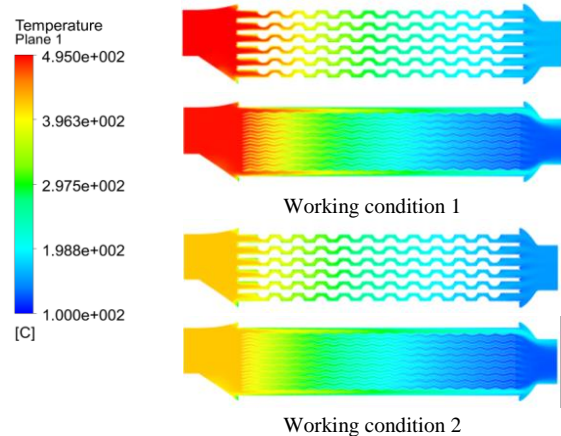

Figure 6. Temperature contours comparison

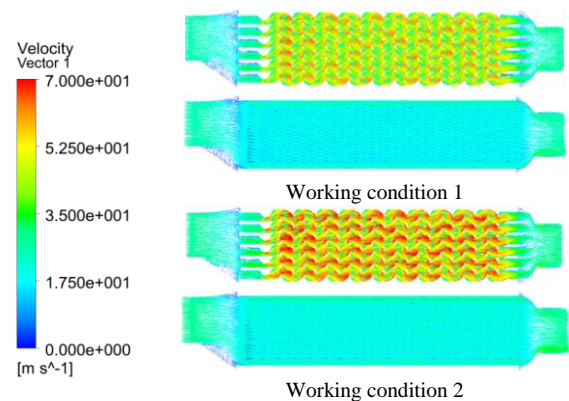

Figure 7. Velocity contours comparison

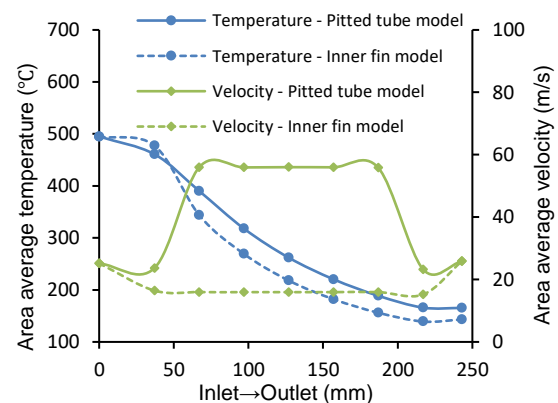

Figure 8. Transverse sections results of working condition 1

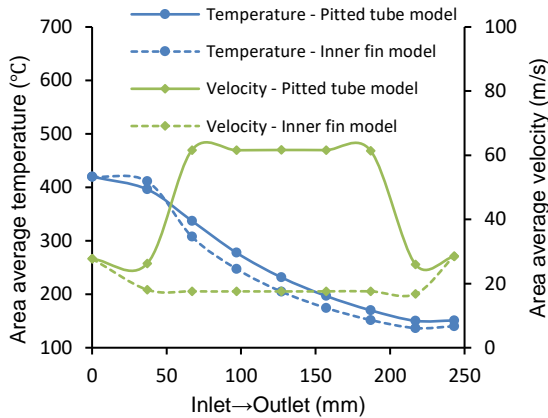

Figure 9. Transverse sections results of working condition 2

From the temperature results in Figures 6, Tables 3 and 4, it is observed that the gas outlet temperature of inner fin model is significantly lower than that in pitted tube model for each working condition. Figures 8 and 9 compare the temperatures from inlet to outlet, the inner fin model shows better cooling performance from section 2 until to outlet. Tables 3 and 4 show that the heat transfer efficiency of the pitted tube is lower than the inner fin schemes. To verify the advantage of the new types of coolers, the heat transfer efficiency results of traditional spiral tube reported in literature [6, 9] are also compared in Figure 10. The advantage of the new types are obvious, the efficiency is improved from 60 to 80% level. Furthermore, the efficiency of the inner fin structure is better than the pitted tube by more than 3~5%. This trend is caused by the indirect area generated by the inner fin model. According to Equations (2), (3) and (4) [20, 21], the heat exchanged between the gas and liquid is related to the heat transfer area, and the outlet temperature will be affected by the heat loss of gas side and heat gained by liquid side. Larger transfer area exchanged more heat and resulted low gas side outlet temperature as compared in Tables 3 and 4.

$$Q = hS\Delta T_{lm} \tag{2}$$

$$Q_g = q_{mg}c_{pg}(t_{gi} - t_{go}) \tag{3}$$

$$Q_l = q_{ml}c_{pl}(t_{li} - t_{lo}) \tag{4}$$

It can also be seen from the comparison of flow velocities in Figures 7, 8 and 9 that the highest gas velocity occurs at the pitted tube model under working condition 2. According to the relationship of velocity and cross-section area given by Equation (5) [22], this high flow velocity is caused by large gas inlet flow and relatively smaller cross-section area. Equation (6) [23] reveals the relationship of pressure drop and velocity, smaller cross-section area subsequently causes larger pressure drop,

this is verified by the pressure drop results in Tables 3 and 4, the inner fin structure gas side pressure drop is only about 17% of the pitted tube structure, this also confirm the volume average velocity results.

$$v = \frac{q_m}{\rho S_s} \tag{5}$$

$$\Delta P = f \frac{L}{D} \frac{\rho v^2}{2g} \tag{6}$$

As discussed above, the present two types of heat transfer structures have obvious advantage in heat transfer efficiency. Because of the unstable diesel quality in China, the reduction of the pressure drop can effectively prevent the formation of carbon deposition, the inner fin type model with low pressure drop will be more suitable for the application. However, the outlet temperature to of the gas side is slightly higher than the design target in condition 1; the inner fin heat transfer structure needs to be optimized to meet the requirements better.

TABLE 3. Results of working condition 1

Model	Pitted tube	Inner fin
t_o (°C)	165.3	143.1
ΔP (Pa)	9890	1728
V_v (m/s)	29.2	16.3
η	80.3%	85.7%

TABLE 4. Results of working condition 2

Model	Pitted tube	Inner fin
t_o (°C)	150.0	140.2
ΔP (Pa)	11583	2031
V_v (m/s)	32.2	18.0
η	80.4%	83.3%

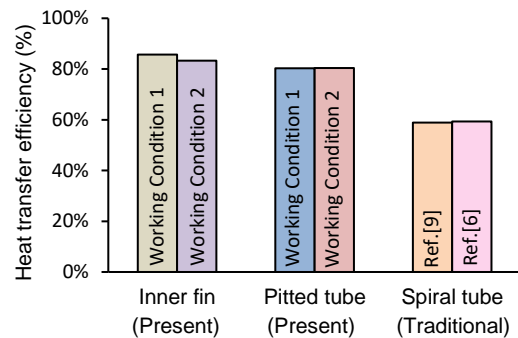

Figure 10. Heat transfer efficiency of different structures

3. INNER FIN STRUCTURE OPTIMIZATION

3.1. Optimization Parameters Determination of Inner Fin

Figure 11 shows the basic structure, the indirect area can be extended and heat transfer performance can be improved by reducing the wavelength L_w and the wave spacing H according to literature [11, 13, 14]. However, the effect of amplitude A has not been clearly studied for an EGR cooler. In theory, when A is reduced, the fin ripple structure tends to be smooth, the indirect transfer area will reduce, which will also reduce the heat transfer ability [24]. When A is increased, the gas turbulence area will extend and the cooling efficiency will be enhanced [25].

The parameters of the original fin model are $L_w = 10$ mm, $H = 2$ mm, and $A = 0.6$ mm. According to design experience and relevant research, the space used to continue to reduce the size of L and H for optimization is very small. Therefore, the main optimization parameter is the fin amplitude A . Based on the original fin structure scheme, different amplitudes $A = 0.9$ mm, $A = 1.2$ mm and $A = 1.5$ mm are built for comparative analysis. Table 5 summarizes the indirect areas of different A .

3.2. Optimization Results and Discussion

The boundary conditions were consistent with those of the earlier stage. Figure 12 is the comparison of the results of outlet temperature and heat transfer efficiency according to changing A . Figure 13 compares the results of gas pressure drop and volume average velocity according to changing in A . Figure 14 illustrates the velocity vector of different A under each working condition.

In Figure 12, it can be found that the outlet temperature and efficiency of condition 1 are higher than condition 2, this trend is related to the relatively high inlet temperature according to Equations (1) ~ (4). Figure 12 also shows that increasing amplitude A (increasing indirect transfer area) results in improvements of the gas outlet temperature and heat transfer performance. When $A = 1.5$ mm, the efficiency is the best, reaching 88.3% in condition 1.

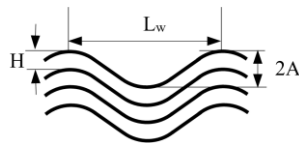

Figure 11. Geometric parameters of wavy inner fin

TABLE 5. Comparison of indirect heat transfer area

A(mm)	0.6	0.9	1.2	1.5
$S_{indirect}(mm^2)$	289523	296646	306711	319535

In Figures 13 and 14, it can be seen that the flow velocity and pressure drop of condition 1 are lower than condition 2 because of the smaller mass flow rate of condition 1, according to Equation (5). In Figures 13 and 14 it also can be seen that the velocity is increased with A , according to the relationship of velocity and pressure given by Equation (6). The pressure drop also increases rapidly, and the pressure drop on the gas side reaches its maximum when $A = 1.5$ mm. When $A = 0.9$ mm, the gas-outlet temperature of condition 1 is 140.2 °C, condition 2 is 137.7 °C, which are close to the design requirements, and the pressure drop of condition 1 is 2121 Pa, condition 2 is 2292 Pa, which are approximately 30% lower than that of $A = 1.5$ mm.

Considering that a larger pressure drop will accelerate the ageing of the cooler, the gas side pressure drop should be reduced as much as possible. According to design experience and similar research, the simulated outlet temperature is usually higher than the experimental value [26, 27], so $A = 0.9$ mm was chosen as the optimized value, it can meet the design requirements and minimize the pressure drop.

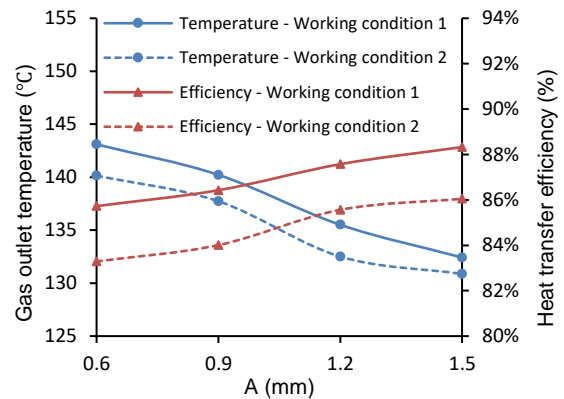

Figure 12. Temperatures and efficiencies of different A

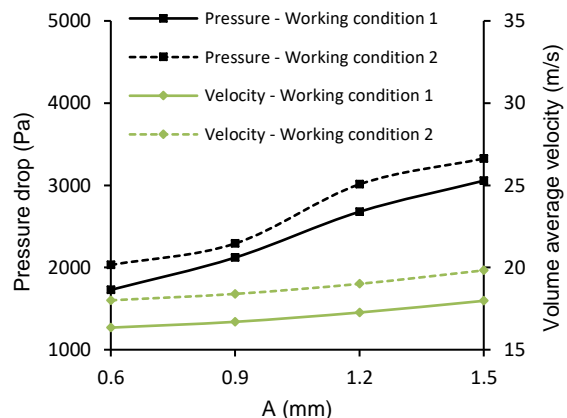

Figure 13. Pressure and velocities of different A

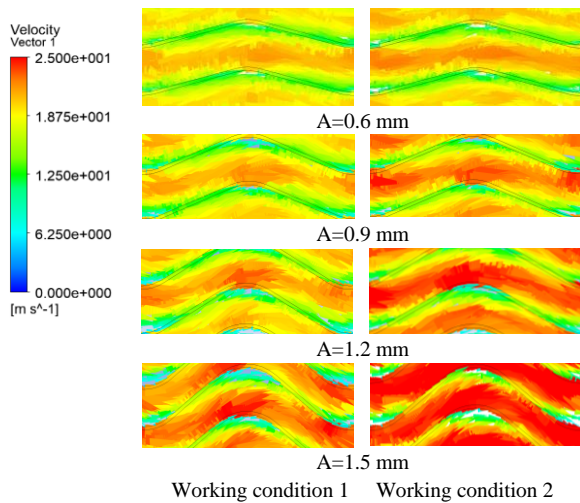

Figure 14. Velocity contours of different A

4. HEAT TRANSFER PERFORMANCE EXPERIMENT

A sample product was manufactured, and the adapter was matched with the heat exchange performance test bench (Figure 15).

Tables 6 and 7 are the experiment and simulation comparisons of the gas side outlet temperatures and heat transfer efficiency under two working conditions, respectively. The difference between the experimental and simulated results is calculated by Equation (7):

$$\text{Difference} = (V_{\text{simulation}} - V_{\text{experiment}}) / V_{\text{experiment}} \times 100\% \quad (7)$$

In Table 6, the simulation data of the gas side outlet temperature is approximately 6% higher than the actual experiment, the calculation accuracy is good, which conforms to the accuracy range of similar simulation [27].

By comparing data stated in Table 7, the actual experimental heat transfer efficiency is slightly higher than that of the simulation value, which also conforms to the trend that the temperature simulation value is higher

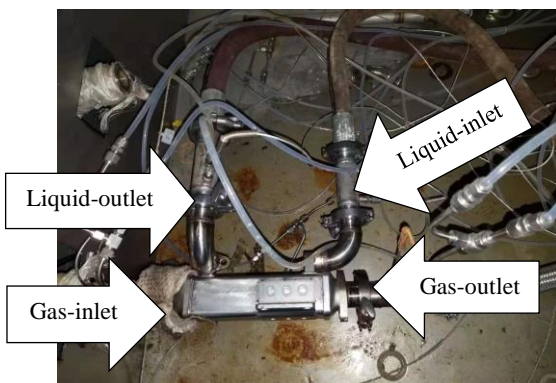

Figure 15. Product and test bench

TABLE 6. Gas outlet temperature comparison

Working condition	Simulation (°C)	Experiment (°C)	Present Difference	Ref. Difference
1	140.2	131.5	6.6%	8.6% [27]
2	137.7	130.0	6.0%	

TABLE 7. Heat transfer efficiency comparison

Working condition	Simulation	Experiment	Present Difference	Ref. Difference
1	86.4%	88.5%	-2.4%	-3.97% [6]
2	84.0%	86.3%	-2.7%	

than the experimental value. The heat transfer efficiency deviation value is less than 3%, compared with the difference of similar study [6], the present simulation accuracy is good.

From the above results, the simulation data and the experimental data are in good agreement. The optimized scheme has a certain design margin, which can effectively compensate for the degradation caused by the ageing during actual use.

5. CONCLUSION

To meet the development requirements, an EGR cooler was designed and manufactured. Two new types of coolers were numerically investigated by comparing the heat transfer area, temperature variation, heat transfer efficiency, flow velocity and gas pressure drop. The efficiency results were also compared by the traditional spiral tube. Then, due to the advantages in comparisons, the inner fin model was selected for subsequent structural optimization to meet the temperature and pressure drop requirements. Finally, the optimized model was verified by experiment, and the following conclusions are obtained:

(1) Heat transfer efficiencies of new types (pitted tube and inner fin) are above 80%, have approximate 20% advantage compared with the traditional spiral tube. The heat transfer efficiency of inner fin model is 3~5% higher than the pitted tube due to the indirect transfer area.

(2) The cross-section flow velocity of inner fin model is about 30% of pitted tube model, and the pressure drop of the inner fin cooler is about only 17% of the pitted tube type. The pressure drop advantage of the inner fin structure is obvious.

(3) Through the inner fin structure optimization, the gas outlet temperature decreases and efficiency increases with the increasing amplitude A. Larger A also leads to high velocity and pressure drop. In order to meet the temperature target and minimize the pressure drop, A is

optimized as 0.9 mm. Numerical $t_{go}=140.2$ °C and 137.7°C, $\Delta P=2121$ Pa and 2292 Pa for working conditions 1 and 2, respectively.

(4) The experimental temperature results are about 6% lower than the numerical values, and the heat transfer efficiency results were slightly higher (less than 3%) than the numerical values. The results are in good agreement with numerical values.

Thus, the study has achieved the purpose of improving the heat transfer performance of an EGR cooler, it will be beneficial for similar developments. However, the optimization was processed by comparing the given geometric parameters, more accurate algorithm and multi parameters optimization will be considered in the future study.

6. REFERENCES

- Shabgard, H., Kheradmand, S., Farzaneh, H. and Bae, C., "Numerical simulation of cooling performance of an exhaust gas recirculation (EGR) cooler using nano-fluids", *Applied Thermal Engineering*, Vol. 110, (2017), 244-252. DOI: 10.1016/j.applthermaleng.2016.08.139
- Hoseini, S.S., Najafi, G., Ghobadian, B., Yusaf, T. and Mamat, R., "Experimental and numerical analysis of flow and heat transfer characteristics of EGR cooler in diesel engine", *Applied Thermal Engineering*, Vol. 140, (2018), 745-758. DOI: 10.1016/j.applthermaleng.2018.05.058
- Kim, H.-M., Lee, D.-H., Park, S.-K., Choi, K.-S. and Wang, H.-M., "An experimental study on heat exchange effectiveness in the diesel engine EGR coolers", *Journal of Mechanical Science and Technology*, Vol. 22, No. 2, (2008), 361-366. DOI: 10.1007/s12206-007-1102-x
- Pourfallah, M., Ranjbar, A.A., Mirsalim, S.M. and Mirsalim, S.M., "Studying the Effect of Reformer Gas and Exhaust Gas Recirculation on Homogeneous Charge Compression Ignition Engine Operation", *International Journal of Engineering, Transactions B: Applications*, Vol. 28, No. 8, (2015), 1199-1208. DOI: 10.5829/idosi.ije.2015.28.08b.13
- Mohebbi, A., Jafarmadar, S., Pashae, J. and Shirmezhad, M., "Experimental Studying of the Effect of EGR Distribution on the Combustion, Emissions and Performance in a Turbocharged DI Diesel Engine", *International Journal of Engineering, Transactions A: Basics*, Vol. 26, No. 1, (2013), 73-82. DOI: 10.5829/idosi.ije.2013.26.01a.10
- Hoseini, S.S., Najafi, G. and Ghobadian, B., "Experimental and numerical investigation of heat transfer and turbulent characteristics of a novel EGR cooler in diesel engine", *Applied Thermal Engineering*, Vol. 108, (2016), 1344-1356. DOI: 10.1016/j.applthermaleng.2016.08.018
- Ghassembaglou, N. and Torkaman, L., "Efficient design of exhaust gas cooler in cold EGR equipped diesel engine", *Alexandria Engineering Journal*, Vol. 55, No. 2, (2016), 769-778. DOI: 10.1016/j.aej.2016.01.023
- Jang, S., Park, S., Choi, K. and Kim, H., "Experimental investigation of the influences of shape and surface area on the EGR cooler efficiency", *Heat and Mass Transfer*, Vol. 47, No. 6, (2010), 621-628. DOI: 10.1007/s00231-010-0754-8
- Seo, Y.-H., Lee, H.-M., Jeon, S.-K., Ku, T.-W., Kang, B.-S. and Kim, J., "Homogenization of dimpled tube and its application to structural integrity evaluation for a dimple-type EGR cooler using FEM", *International Journal of Precision Engineering and Manufacturing*, Vol. 13, No. 2, (2012), 183-191. DOI: 10.1007/s12541-012-0023-5
- Fu, Z., Research on Heat Transfer Performance of Pits Flat Tube. 2016, Hubei University of Technology: Wuhan.
- Park, S., Choi, K., Kim, H. and Lee, K., "Influence of PM fouling on effectiveness of heat exchanges in a diesel engine with fin-type EGR coolers of different sizes", *Heat and Mass Transfer*, Vol. 46, No. 11-12, (2010), 1221-1227. DOI: 10.1007/s00231-010-0652-0
- Park, S.-K., Lee, J. and Kim, H.-M., "Experimental study on the spiral and oval spiral EGR cooler efficiencies in a diesel engine", *Heat and Mass Transfer*, Vol. 50, No. 12, (2014), 1783-1789. DOI: 10.1007/s00231-014-1362-9
- Lee, J. and Min, K., "A study of the fouling characteristics of EGR coolers in diesel engines", *Journal of Mechanical Science and Technology*, Vol. 28, No. 8, (2014), 3395-3401. DOI: 10.1007/s12206-014-0752-8
- Jang, S.-H., Hwang, S.-J., Park, S.-K., Choi, K.-S. and Kim, H.-M., "Effects of PM fouling on the heat exchange effectiveness of wave fin type EGR cooler for diesel engine use", *Heat and Mass Transfer*, Vol. 48, No. 6, (2011), 1081-1087. DOI: 10.1007/s00231-011-0950-1
- Kostikov, Y.A. and Romanenkov, A.M., "Approximation of the Multidimensional Optimal Control Problem for the Heat Equation (Applicable to Computational Fluid Dynamics (CFD))", *Civil Engineering Journal*, Vol. 6, No. 4, (2020), 743-768. DOI: 10.28991/cej-2020-03091506
- Topçuoğlu, K., "Trombe Wall Application with Heat Storage Tank", *Civil Engineering Journal*, Vol. 5, No. 7, (2019), 1477-1489. DOI: 10.28991/cej-2019-03091346
- Janani, M., Prakash, D., Harini, E. and Harish, T., "Enhancement of Heat Transfer over a Double Forward Facing Step with Square Obstacle through Taguchi's Optimization Technique", *International Journal of Engineering, Transactions B: Applications*, Vol. 30, No. 8, (2017), 1253-159. DOI: 10.5829/ije.2017.30.08b.19
- Sengupta, A.R., Gupta, R. and Biswas, A., "Computational Fluid Dynamics Analysis of Stove Systems for Cooking and Drying of Muga Silk", *Emerging Science Journal*, Vol. 3, No. 5, (2019), 285-292. DOI: 10.28991/esj-2019-01191
- Chen, Y.Y., Cai, Y.X., Li, X.H., Shi, Y.X. and Zheng, Y., "Experimental study on regenerating fouled EGR cooler by ntpi technology", *International Journal of Automotive Technology*, Vol. 16, No. 2, (2015), 183-191. DOI: 10.1007/s12239-015-0020-7
- Pradeep, G.V. and Narasimha, K.R., "Experimental Investigations on the Thermal Performance of a Vertical Closed Loop Pulsating Heat Pipe Using Binary Mixture of Fluids", *International Journal of Engineering, Transactions B: Applications*, Vol. 31, No. 5, (2018). DOI: 10.5829/ije.2018.31.05b.16
- Zhang, W., Yang, X., Wang, T., Peng, X. and Wang, X., "Experimental Study of a Gas Engine-driven Heat Pump System for Space Heating and Cooling", *Civil Engineering Journal*, Vol. 5, No. 10, (2019), 2282-2295. DOI: 10.28991/cej-2019-03091411
- F.Bailin, Pei, Z., H.Ganghan and W.YanJun, "Research on Properties of Fluid Pressure Drop for Electric Vehicle IGBT Pin Fin Heat Sink", *International Journal of Engineering, Transactions A: Basics*, Vol. 28, No. 4(A), (2015). DOI: 10.5829/idosi.ije.2015.28.04a.18
- Al-Obaidi, A.R., "Investigation of fluid field analysis, characteristics of pressure drop and improvement of heat transfer in three-dimensional circular corrugated pipes", *Journal of Energy Storage*, Vol. 26, (2019), 101012. DOI: 10.1016/j.est.2019.101012

24. Li, X.N., Research on design and performance optimization of diesel engine waste heat recovery bottoming system and exhaust heat exchanger. 2014, Tianjin University: Tianjin.
25. Wang, Y., He, H., Xu, Z. and Liu, J., "Thermodynamic Performance Simulation of Diesel EGR Cooler with Finned Tube", *Advanced Materials Research*, Vol. 97-101, (2010), 3345-3348. DOI: 10.4028/www.scientific.net/AMR.97-101.3345
26. Ren, X.S., Simulation and experimental study on EGR cooler of automobile diesel engine. 2013, Zhejiang University: Hangzhou.
27. Lu, L., Zhang, Z.D. and Yin, C.B., "Performance simulation and structure improvement of EGR cooler", *China Mechanical Engineering*, Vol. 26, No. 17, (2015), 2369-2373. DOI: 10.3969/j.issn.1004-132X.2015.17.016

Persian Abstract

چکیده

به منظور بهبود عملکرد انتقال حرارت کولر گشتاور آگزوز (EGR)، خصوصیات ساختاری مختلف به صورت عددی و تجربی مورد مطالعه قرار گرفته است. در آنالیزهای عددی، مدل لوله سوراخ دار ارائه شده و مدل باله داخلی در دو شرایط کاری معمولی مقایسه می شوند، راه حل های بازده انتقال حرارت مدل باله داخلی ۳۳۵ بیشتر از مدل لوله سوراخ دار است. مدل داخلی باله همچنین افت فشار جانبی گاز کمتری را نشان می دهد که تنها ۱۷٪ مدل لوله سوراخ دار است. سپس بهینه سازی ساختاری مدل باله داخلی با تجزیه و تحلیل دامنه های مختلف A مورد بررسی قرار گرفت. نشان داده شده است که افزایش A منجر به افزایش راندمان انتقال حرارت و افت فشار جانبی گاز می شود، دمای مورد نیاز رضایت بخش است هنگامی که $A = 0.9$ میلی متر افت می کند افت فشار به حداقل می رسد. راه حل های بهینه سازی انتقال حرارت عددی بهینه شده ۸۶٪ درصد و ۸۴ درصد و نتایج آزمایش به ترتیب با ۸۷/۵ درصد و ۸۶/۳ درصد مربوط به شرایط کار بودند. توافق خوبی حاصل شد. از ساختار باله داخلی بهینه شده می توان برای بهبود عملکرد انتقال حرارت برای یک کولر EGR استفاده کرد، روش مطالعه با استفاده از شبیه سازی ها و آزمایشات اثبات شده است.
